

CamRecord CR Series
CR450x2 (x3)
CR600x2
CR1000x2 (x3)
CR3000x2
CR4000x2
CR5000x2

Ver. -

User Manual

Ref. 1830-SU-02-N

Contents

General	4
Declaration of conformity	4
RoHS compliance	4
Scope of delivery	5
Optronis customer service	10
Safety Instructions	11
Typical System Configuration	12
Quick Start Instructions	13
C-Mount	13
To mount the C-Mount lens	13
To unmount the C-Mount lens	13
Nikon F-Mount	14
To mount the Nikon F-Mount lens	14
To unmount the Nikon F-Mount lens	15
Nikon F-Mount for G Objektiv (/FMG)	16
Nikon G lenses	16
To mount the Nikon G lens	16
To unmount the Nikon F-Mount lens	18
Canon Mount for EF and EFS lenses (/EM)	19
Canon EF/EFS lenses	19
To mount the Canon lens	19
To unmount the Canon lens	21
Start of operation	22
Camera	24
Lens Interface	24
Accessories	24
Camera Socket	24
Electrical Interface	25
VGA Connector	25
Power Supply Input / Power Connector	26
Power-LED	26
GigE Connector	26
GigE Communication-LEDs	26
Trigger / Sync Connector (Aux.)	26
External Trigger (Trig In)	27
Trigger Control-LED	27
External Synchronisation Input (Sync In)	27
Synchronisation Output	28
AccuPack (/BI)	29
Camera Backside	29
Install AccuPack	29
Change Accumulator, Unconnect Charger	32
Important Hints	33
Operation	34
Power Supply	36

Laptop (PC)	36
CamControl Software	38
TimeBench Software	38
Technical Data	39
CR450x2	39
Spectral Response / Transmittance	39
Bayer Pattern	40
CR450x3	41
Spectral Response / Transmittance	41
Bayer Pattern	42
CR600x2	43
Spectral Response / Transmittance	43
Bayer Pattern	44
CR1000x2	45
Spectral Response / Transmittance	45
Bayer Pattern	46
CR3000x2	47
Spectral Response / Transmittance	47
CR1000x3	49
Spectral Response / Transmittance	49
CR4000x2	51
Spectral Response / Transmittance	51
CR5000x2	53
Spectral Response / Transmittance	53
Bayer Pattern	54
AccuPack (/BI)	55
Performance (Examples)	56
CR450x2	56
CR450x3	56
CR600x2	56
CR1000x2	56
CR1000x3	57
CR3000x2	57
CR4000x2	57
CR5000x2	58
Mechanical Dimensions	59
CR Series (/FM, /FMG)	59
CR Series (/FM, /FMG, /BI)	61
CR Series (/EM)	63
External Inputs	65
Trigger & Synchronisation input	65
Synchronisation Timing	65
Trigger Timing	66
External Outputs	67
Synchronisation output	67
Synchronisation Timing	67
Focal Length Calculation	69
CR450x2	69
Full Sensor Resolution	69
Reduced Sensor Resolution	69

Distance Washer	71
CR600x2	72
Full Sensor Resolution	72
Reduced Sensor Resolution	72
Distance Washer	74
CR1000x2	75
Full Sensor Resolution	75
Reduced Sensor Resolution	75
Distance Washer	77
CR3000x2	78
Full Sensor Resolution	78
Reduced Sensor Resolution	78
Distance Washer	80
CR4000x2	81
Full Sensor Resolution	81
Reduced Sensor Resolution	81
Distance Washer	83
CR5000x2	84
Full Sensor Resolution	84
Reduced Sensor Resolution	84
Distance Washer	86
Illumination	87

General

Declaration of conformity

Manufacturer: Optronis GmbH
Address: Ludwigstr. 2, 77694 Kehl, Germany

We certify and declare under our sole responsibility that the following apparatus

Product: CR450x2, CR450x3, CR600x2, CR1000x2, CR1000x3
CR3000x2, CR4000x2, CR5000x2

conform with the essential requirements of the EMC Directive 2004/108/EC, based on the following specifications applied:

Specifications: EN 61000-6-3 Emission
 EN 61000-6-1 Immunity

Kehl, 12.06.2014

Optronis GmbH
Dr. Patrick Summ
Managing Director

RoHS compliance



CamRecord CR series cameras are Pb free manufactured.

Scope of delivery

CR450x2 CamRecord High-Speed camera

Options: /C: Color sensor (Bayer Pattern)
 (IR Cutoff Filter, Specification: 1830-SS-10)
 /M: Monochrome sensor
 /1GB: 1 GByte Memory
 /2GB: 2 GByte Memory
 /4GB: 4 GByte Memory
 /8GB: 8 GByte Memory
 /16GB: 16 GByte Memory
 /MS: Multisequence / Multisegment
 CR-SDK: Software Development Kit
 CR-Labview: Labview Driver
 /BI: Battery Pack

Lens mount: /CM: CMount
 /FM: FMount
 /FMG: FMount and Nikon G-Lenses
 /EM: Canon EF/EFS lenses (automatic focus / aperture)

Power supply: +12Volt / 2,5Amp., 100 .. 240VAC/50-60Hz

External Synchronisation / Trigger Adapter cable

User Manual

CamControl software (CD-ROM) for camerasystems before 03.2010

TimeBench software (CD-ROM) for camerasystems after 03.2010

CR450x3 CamRecord High-Speed camera

Options: /C: Color sensor (Bayer Pattern)
 (IR Cutoff Filter, Specification: 1830-SS-10)
 /M: Monochrome sensor
 /1GB: 1 GByte Memory
 /2GB: 2 GByte Memory
 /4GB: 4 GByte Memory
 /8GB: 8 GByte Memory
 /16GB: 16 GByte Memory
 /MS: Multisequence / Multisegment
 CR-SDK: Software Development Kit
 CR-Labview: Labview Driver

/BI: Battery Pack
Lens mount: /CM: CMount
/FM: FMount
/FMG: FMount and Nikon G-Lenses
/EM: Canon EF/EFS lenses (automatic focus / aperture)
Power supply: +12Volt / 2,5Amp., 100 .. 240VAC/50-60Hz
External Synchronisation / Trigger Adapter cable
User Manual
TimeBench software (CD-ROM) for camerasystems after 03.2010

CR600x2 CamRecord High-Speed camera

Options: /C: Color sensor (Bayer Pattern)
(IR Cutoff Filter, Specification: 1830-SS-10)
/M: Monochrome sensor
/2GB: 2 GByte Memory
/4GB: 4 GByte Memory
/8GB: 8 GByte Memory
/16GB: 16 GByte Memory
/UF: Ultra Format (free Software Feature after 03.2010)
CR-SDK: Software Development Kit
CR-Labview: Labview Driver
/BI: Battery Pack
Lens mount: /CM: CMount
/FM: FMount
/FMG: FMount and Nikon G-Lenses
/EM: Canon EF/EFS lenses (automatic focus / aperture)
Power supply: +12Volt / 2,5Amp., 100 .. 240VAC/50-60Hz
External Synchronisation / Trigger Adapter cable
User Manual
CamControl software (CD-ROM) for camerasystems before 03.2010
TimeBench software (CD-ROM) for camerasystems after 03.2010

CR1000x2 CamRecord High-Speed camera

Options: /C: Color sensor (Bayer Pattern)
(IR Cutoff Filter, Specification: 1830-SS-10)

/M: Monochrome sensor
/2GB: 2 GByte Memory
/4GB: 4 GByte Memory
/8GB: 8 GByte Memory
/16GB: 16 GByte Memory
/UF: Ultra Format (free Software Feature after 03.2010)
/US: Ultra Speed
CR-SDK: Software Development Kit
CR-Labview: Labview Driver
/BI: Battery Pack
Lens mount: /CM: CMount
/FM: FMount
/FMG: FMount and Nikon G-Lenses
/EM: Canon EF/EFS lenses (automatic focus / aperture)
Power supply: +12Volt / 2,5Amp., 100 .. 240VAC/50-60Hz
External Synchronisation / Trigger Adapter cable
User Manual
CamControl software (CD-ROM) for camerasystems before 03.2010
TimeBench software (CD-ROM) for camerasystems after 03.2010

CR1000x3 CamRecord High-Speed camera

Options: /C: Color sensor (Bayer Pattern)
(IR Cutoff Filter, Specification: 1830-SS-10)
/M: Monochrome sensor
/2GB: 2 GByte Memory
/4GB: 4 GByte Memory
/8GB: 8 GByte Memory
/UF: Ultra Format (free Software Feature after 03.2010)
CR-SDK: Software Development Kit
CR-Labview: Labview Driver
/BI: Battery Pack
Lens mount: /CM: CMount
/FM: FMount
/FMG: FMount and Nikon G-Lenses
/EM: Canon EF/EFS lenses (automatic focus / aperture)
Power supply: +12Volt / 2,5Amp., 100 .. 240VAC/50-60Hz

External Synchronisation / Trigger Adapter cable

User Manual

TimeBench software (CD-ROM)

CR3000x2 CamRecord High-Speed camera

Options: /C: Color sensor (Bayer Pattern)
 (IR Cutoff Filter, Specification: 1830-SS-10)
 /M: Monochrome sensor
 /2GB: 2 GByte Memory
 /4GB: 4 GByte Memory
 /8GB: 8 GByte Memory
 /UF: Ultra Format (free Software Feature after 03.2010)
 CR-SDK: Software Development Kit
 CR-Labview: Labview Driver
 /BI: Battery Pack

Lens mount: /CM: CMount
 /FM: FMount
 /FMG: FMount and Nikon G-Lenses
 /EM: Canon EF/EFS lenses (automatic focus / aperture)

Power supply: +12Volt / 2,5Amp., 100 .. 240VAC/50-60Hz

External Synchronisation / Trigger Adapter cable

User Manual

TimeBench software (CD-ROM)

CR5000x2 CamRecord High-Speed camera

Options: /C: Color sensor (Bayer Pattern)
 (IR Cutoff Filter, Specification: 1830-SS-10)
 /M: Monochrome sensor
 /2GB: 2 GByte Memory
 /4GB: 4 GByte Memory
 /8GB: 8 GByte Memory
 /16GB: 16 GByte Memory
 /UF: Ultra Format (free Software Feature after 03.2010)
 /US: Ultra Speed
 CR-SDK: Software Development Kit

CR-Labview: Labview Driver
/BI: Battery Pack
Lens mount: /CM: CMount
/FM: FMount
/FMG: FMount and Nikon G-Lenses
/EM: Canon EF/EFS lenses (automatic focus / aperture)
Power supply: +12Volt / 2,5Amp., 100 .. 240VAC/50-60Hz
External Synchronisation / Trigger Adapter cable
User Manual
CamControl software (CD-ROM) for camerasystems before 03.2010
TimeBench software (CD-ROM) for camerasystems after 03.2010

CR4000x2 CamRecord High-Speed camera

Options: /C: Color sensor (Bayer Pattern)
(IR Cutoff Filter, Specification: 1830-SS-10)
/M: Monochrome sensor
/2GB: 2 GByte Memory
/4GB: 4 GByte Memory
/8GB: 8 GByte Memory
/UF: Ultra Format (free Software Feature after 03.2010)
/US: Ultra Speed
CR-SDK: Software Development Kit
CR-Labview: Labview Driver
/BI: Battery Pack
Lens mount: /CM: CMount
/FM: FMount
/FMG: FMount and Nikon G-Lenses
/EM: Canon EF/EFS lenses (automatic focus / aperture)
Power supply: +12Volt / 2,5Amp., 100 .. 240VAC/50-60Hz
External Synchronisation / Trigger Adapter cable
User Manual
CamControl software (CD-ROM) for camerasystems before 03.2010
TimeBench software (CD-ROM) for camerasystems after 03.2010

Optronis customer service

Optronis GmbH
Honsellstrasse 8
77694 Kehl
Tel: +49 (0) 7851 9126 0
Fax: +49 (0) 7851 9126 10
e-mail: info@optronis.com

For any questions or problems, please do not hesitate to ask our customer service. Please prepare the following information:

- Name of the device:
(CamRecord CR450x2 (x3), CR600x2, CR1000x2 (x3), CR3000x2, CR4000x2, CR5000x2)
- Serial-Number:
(see label at the bottom side of the camera)
- Software Version:
(Info-Menu of the CamControl or TimeBench software)
- Short description of the problem

Safety Instructions

- Please operate the CamRecord CR cameras from a 110 Volt to 240 Volt (50 Hz to 60 Hz a.c. frequency) power source. Other voltage levels or frequencies may damage the camera.
- Do not orientate the optical input of the camera to direct sunlight.
- Keep the camera free protected from dirt, dust, grease and water.
- Make sure that all the connecting cables are in good condition and that they are well mounted to their sockets.
- Please use the socket of the camera and connect it to a sufficiently stable basis.
- Avoid strong system shocks and vibrations during transport or during operation.
- Always unplug the camera before cleaning it. Do not use cleaning liquids or sprays. Instead, use a dry and soft duster.
- For any further questions please do not hesitate to contact Optronis GmbH, especially when the camera do not work as it is described in the user manual.

Typical System Configuration

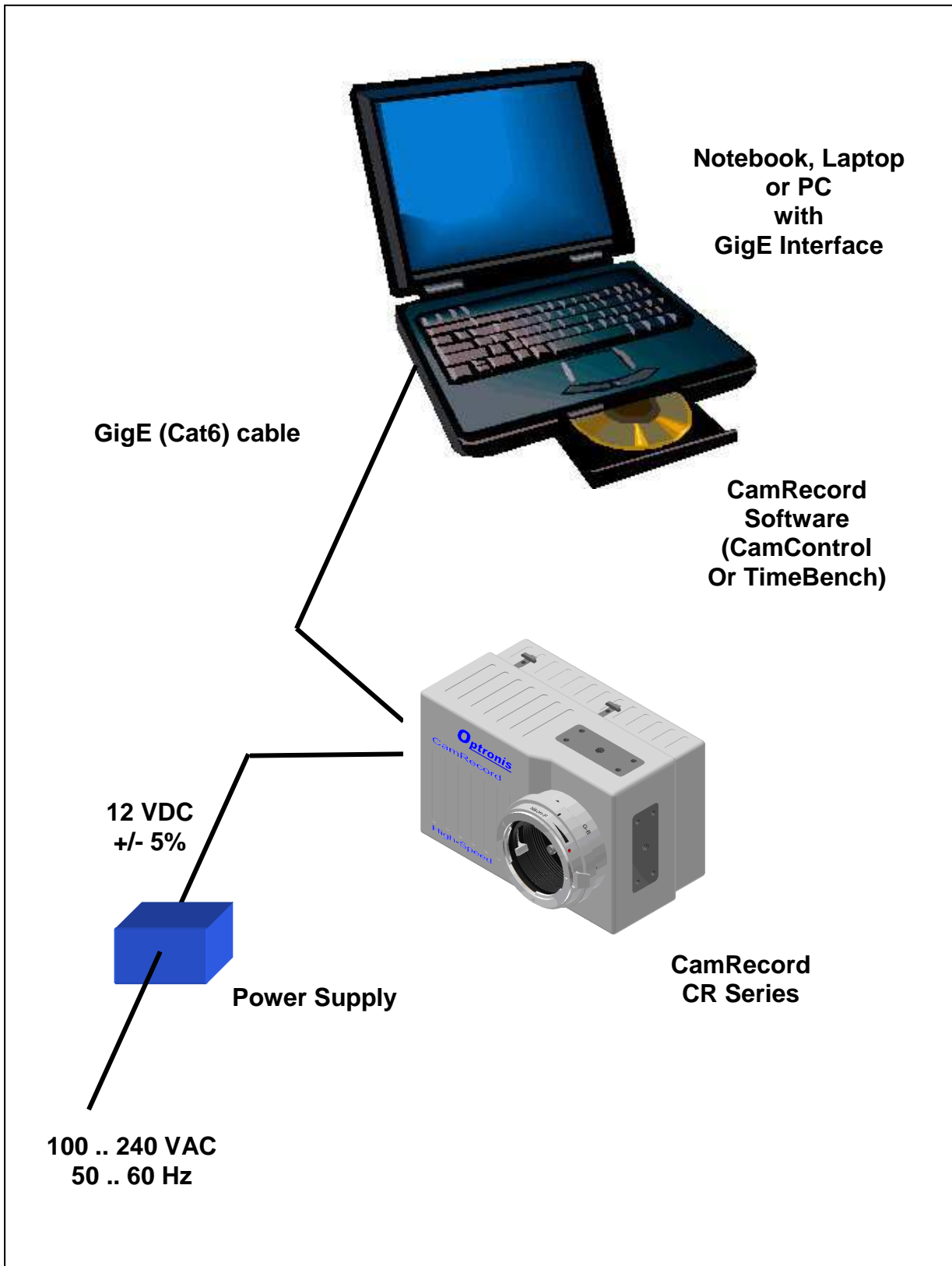

Figure 1: Typical System Configuration

Quick Start Instructions

C-Mount



To mount the C-Mount lens

Please unscrew the protective cover anti-clockwise and mount the C-Mount lens into the lens holder.

To unmount the C-Mount lens

To unmount the lens please unmount the C-Mount lens anti-clockwise.

Nikon F-Mount

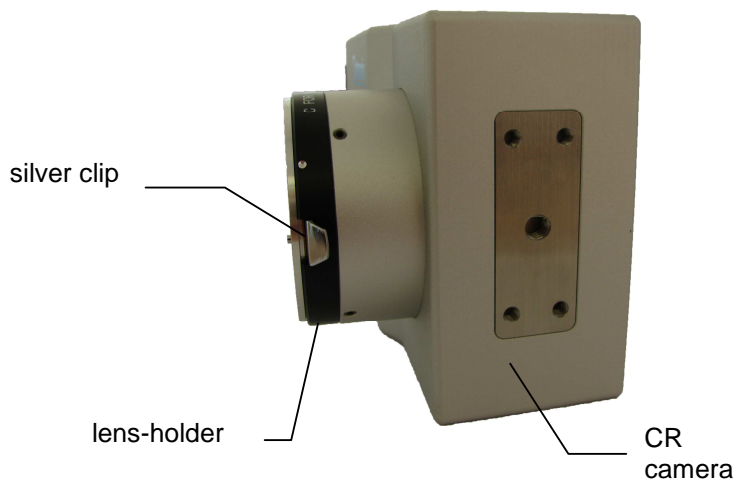

To mount the Nikon F-Mount lens

The lens has to be positioned on the lens-holder in a way, that the back surface of the lens is completely attached to the surface of the lens-holder. The lens-reference has to be in face to the lens-holder reference. Then, the lens has to be turned anti-clockwise until the silver clip on the lens-holder locks.

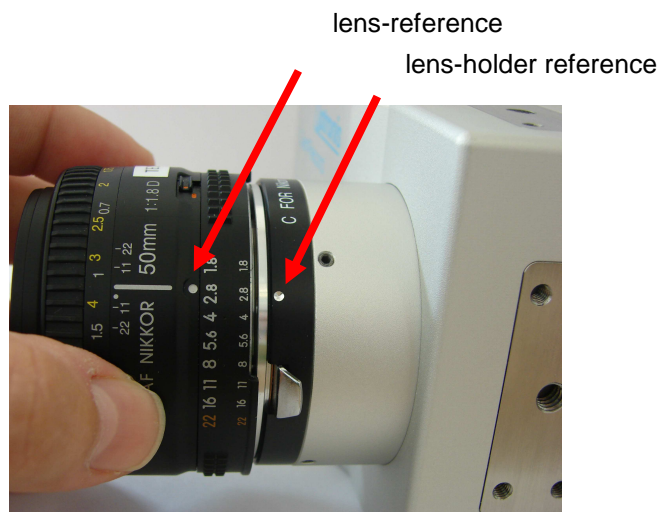

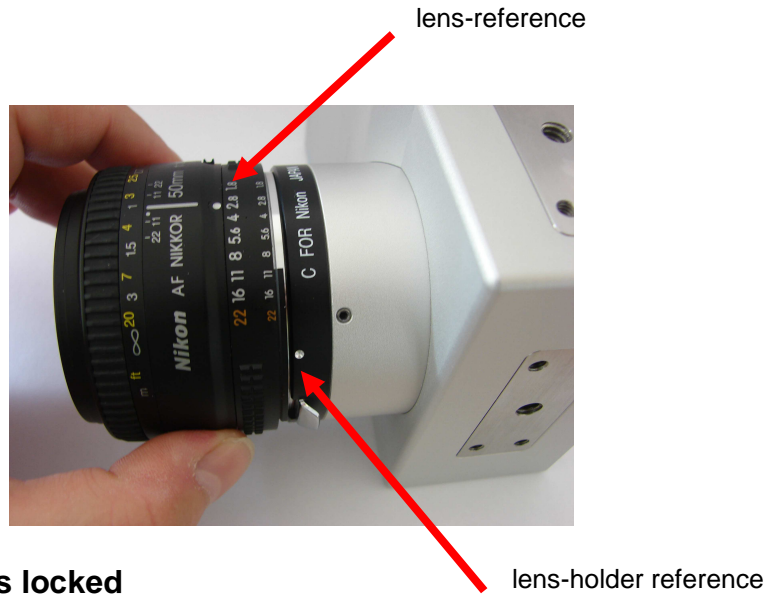

To unmount the Nikon F-Mount lens

To unmount the lens please pull back first the silver clip back in order to unlock the lens. Then -the silver clip has still to be pulled back- the lens has to be turned clockwise until the lens is unmounted completely.



Nikon F-Mount for G Objektiv (/FMG)



Nikon G lenses

Nikon G lenses are optimized for digital photography but don't offer mechanical aperture adjustment. The Nikon /FMG Adapter allows even with these lenses to perform mechanical aperture adjustment by use of an adjustment ring on the lens holder. The adjustment of the aperture is performed continuously.



When mounting a standard F-Mount lens (with mechanical aperture ring) onto the /FMG adapter, please pay attention, that the aperture ring on the adapter don't affects the aperture adjustment on the lens. Please turn the aperture ring of the adapter clock-wise (seen from the front) to its mechanical stop.

To mount the Nikon G lens

The lens has to be positioned on the lens-holder in a way, that the back surface of the lens is completely attached to the surface of the lens-holder. The lens-reference has to be in face to the lens-holder reference. Then, the lens has to be turned anti-clockwise until the silver clip on the lens-holder locks.

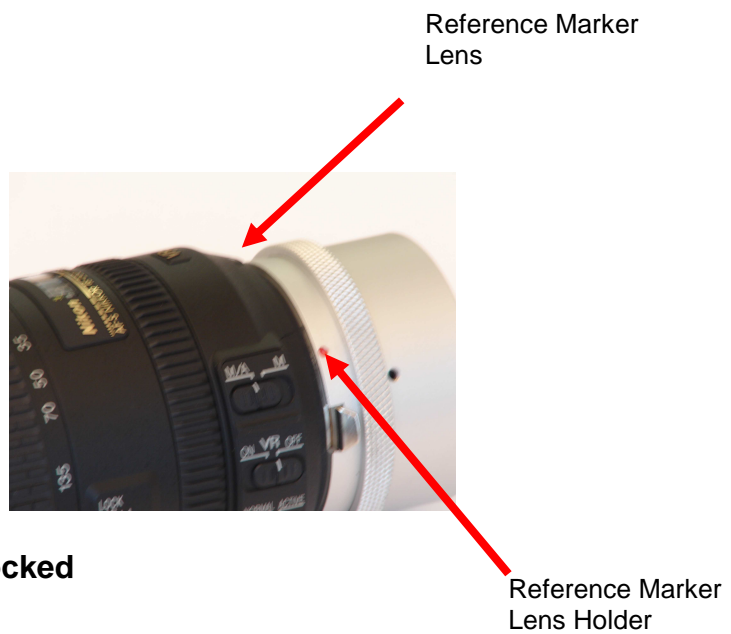
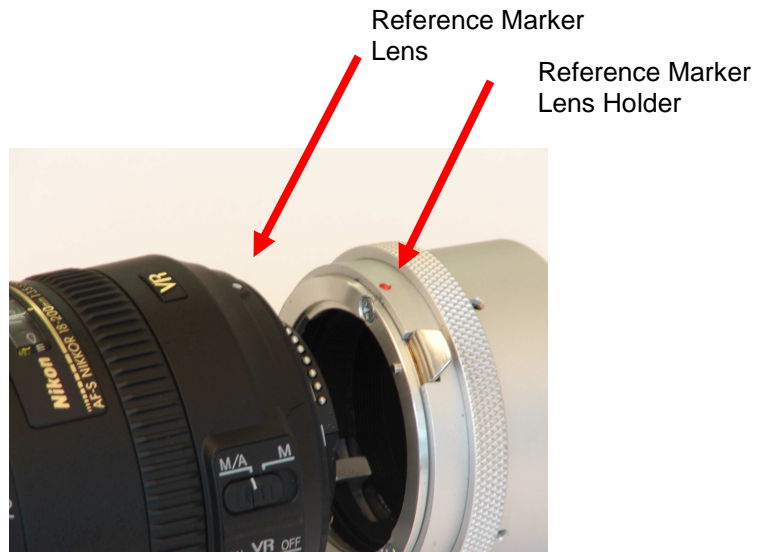

To unmount the Nikon F-Mount lens

To unmount the lens please pull back first the silver clip back in order to unlock the lens. Then -the silver clip has still to be pulled back- the lens has to be turned clockwise until the lens is unmounted completely.



Canon Mount for EF and EFS lenses (/EM)

Lens-
holder



Locking button

Canon EF/EFS lenses

Canon EF/EFS Objektiv don't offer a mechanical aperture ring. Adjustment of the aperture and the focus position is performed electrically by the TimeBench Software.



Please note, that the focus position can only applied by software, when the button on the lens is positioned on „AF“ (Auto Focus). „MF“ (Manual Focus) Position allows to adjust the focus position manually by the focus ring on the lens.

To mount the Canon lens

The lens has to be positioned on the lens-holder in a way, that the back surface of the lens is completely attached to the surface of the lens-holder. The lens-reference has to be in face to the lens-holder reference. Then, the lens has to be turned clockwise until the locking button on the lens-holder locks.

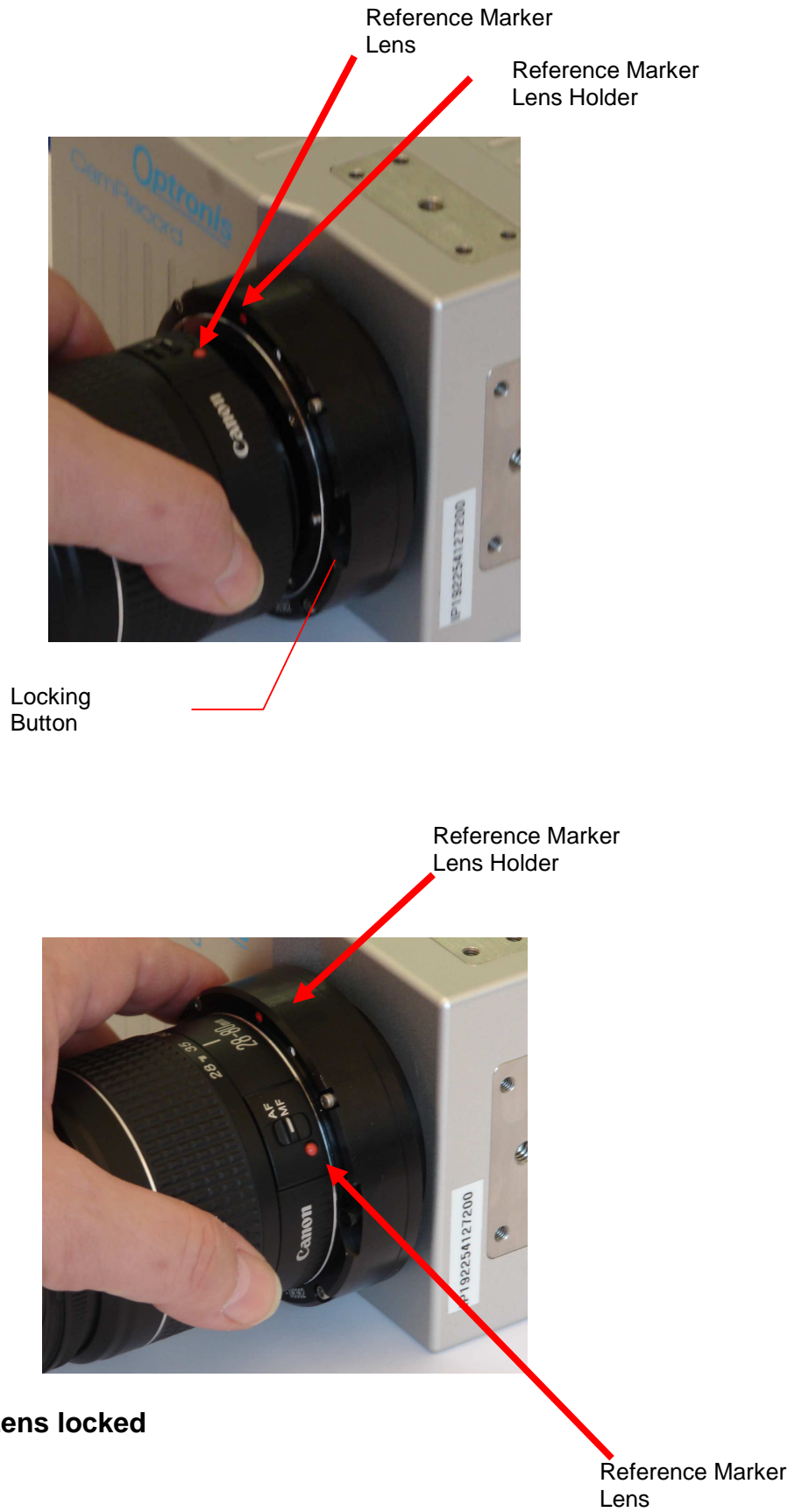

To unmount the Canon lens

To unmount the lens please push first the locking button in order to unlock the lens. Then -the locking button has still to be pushed- the lens has to be turned anti-clockwise until the lens is unmounted completely.



Push locking
button

Start of operation

1. To operate the CamRecord CR cameras, please select first the IP address of the GigE Network as it is described in the “GigE Network” user manual. Make sure, that your Laptop (PC) provides a Gigabit Ethernet (GigE) interface.

After selection of the IP address, the software (CamControl or TimeBench) can be installed.

2. When IP address is selected and software are already installed, the camera can be operated directly:

Please connect the camera power supply to the power connector of the CR camera and connect then the power supply to the 110-240 Volt power source. The camera will operate immediately when connection to the power supply is done. The green LED above the power connector will glow green

Please connect then the GigE (Cat 6) cable to the Laptop (PC) and to the connector of the camera.

Switch on the CamControl or TimeBench software on your Laptop (PC). The software will start automatically and will connect the Laptop (PC) to the camera.

3. To verify immediately the operation of the camera, the following parameters in the “Setup-Menu” of the software can be selected:

Frame Format:	800 x 600 (CR450x2)
	1024 x 1024 (CR450x3)
	1280 x 1024 (CR600x2)
	1280 x 1024 (CR1000x2 (x3))
	1696 x 1710 (CR3000x2)
	512 x 512 (CR5000x2)
	2304 x 1720 (CR 4000x2)
Frame Rate:	50 fps
Exposure Time:	1/50
Synchronisation:	internal

Select then “Video-Live” in the “Acquisition-Menu”. The camera transfers now live-images to the monitor of the Laptop (PC).

To optimize now the image in a most simple way, please open or close the iris and adjust the focus of the lens.

Remark:

When the communication from the Laptop (PC) to the camera fail, the software will start first with a message box.

In this case please make sure, that the camera is well supplied by the power-supply and that the camera is well connected to the Laptop (PC).

Please make also sure, that the IP address is installed correctly as described in the "GigE Network Setup (document 1830-SU-05)" user manual.

Please contact Optronis GmbH when the camera will not communicate with the computer.

Camera



- | | |
|-------------------------|-----------------------------|
| 1: Lens interface | 2: Camera socket |
| 3: Electrical interface | 4: Label with Serial Number |

Figure 2: CamRecord CR Camera View

Lens Interface

In the standard version, the CR camera will be delivered with a Nikon-F Mount lens interface (Option /FM).

Remark:

For special needs, the CamRecord cameras may also be used with C-Mount (Option /CM), F-Mount for G lenses (Option /FMG) or Canon EF/EFS lenses (Option /EM). Other lens interfaces as e.g. CS-Mount and metrical formats can be foreseen. Please contact Optronis GmbH.

Accessories

Macro- and magnification-applications may need special distance washers between lens interface and lens as e.g. the PK-11A (8mm length) from Nikon. Distance washers are available for Nikon F-Mount and C-Mount.

Camera Socket

The socket at the bottom/right/top side of the camera is used

- to fasten the camera to a tripod or special holders by use of the five screw threads (1x 1/4"-20UMC in the middle or 4x M4 in the corners).

Electrical Interface

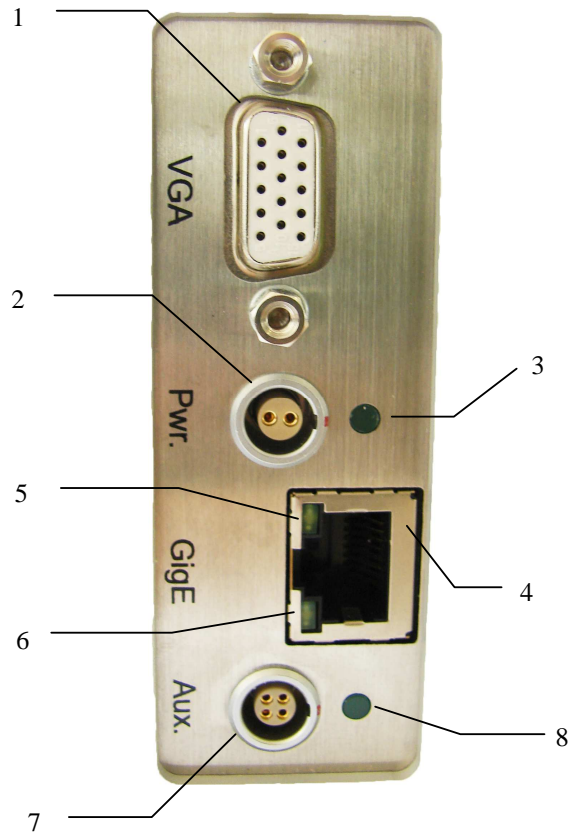

- | | |
|-----------------------------|-----------------------------|
| 1: VGA Connector | 6: GigE Communication LED 2 |
| 2: Power Connector | 7: Sync. / Trig. Connector |
| 3: Power LED | 8: Trigger Control LED |
| 4: GigE Connector | |
| 5: GigE Communication LED 1 | |

Figure: CR Camera electrical interface

VGA Connector

The cameras show live images on the VGA Connector during Live Mode (only CR5000x2) and during Record (CR450x2, CR600x2, CR1000x2, CR5000x2, CR4000x2). This allows to optimise operating conditions of the application as e.g. illumination condition or lens condition as e.g. focus, iris and magnification.

Power Supply Input / Power Connector

The cameras are supplied by a 12 Volt DC power source which is delivered by the camera power supply. When connecting the power supply, the camera is immediately operating and ready for data transfer.

Remark:

Please use always the power supply that is foreseen for the camera. When the camera shall be supplied by another power source please contact first Optronis GmbH.

Power-LED

During operation of the camera the power-LED glues green. If this is not the case please make sure, that the camera is supplied correctly by the camera power supply.

GigE Connector

The GigE Connector is used to communicate with a Laptop (PC). Please use Cat 6 Patchcable between camera and PC.

GigE Communication-LEDs

Both LEDs glue green, when a GigE connection to the PC will be established. The LED 1 (upper side) blinks, when a communication to the PC will be performed as e.g. during data transfer.

Trigger / Sync Connector (Aux.)

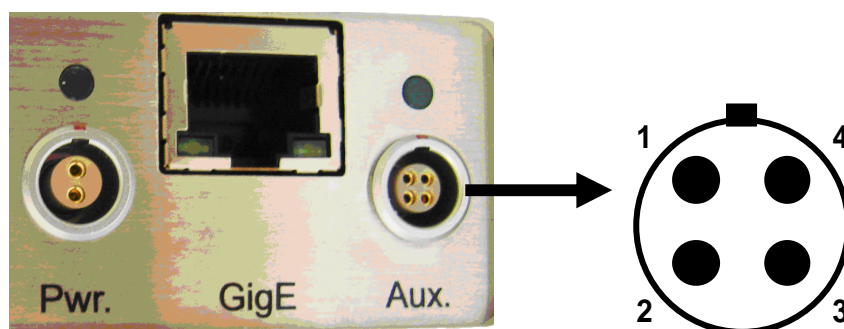

1: Sync In
2: Trig In

3: GND
4: Sync Out

External Trigger (Trig In)

The external trigger input can be used to trigger a sequence. The schematic below shows the input schematic of the input.

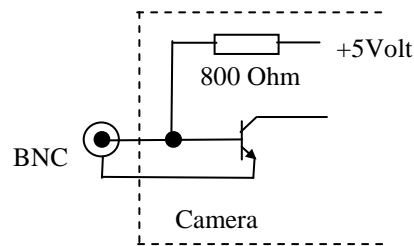

Figure 4: Trigger Input, schematical presentation

Please look at the Appendix for detailed technical specification.

External TTL

Allows to use a TTL signal at the BNC connector of the trigger input. The trigger is rising edge sensitive.

External Switch

Allows to use an external switch, a TTL signal or an open collector to trigger the sequence. The trigger signal is falling edge sensitive which means, that e.g. the switch has to be closed to trigger the sequence.

Trigger Control-LED

The Trigger Control-LED shows, if a trigger signal has been detected by the camera. In this case, the LED goes on for about one second.

External Synchronisation Input (Sync In)

The camera allows to be externally synchronized by an external pulse generator to frame rates, which are not given by the internal frame rates of the camera. To do this, a TTL signal has to be applied to the external synchronisation input. The camera detects the rising edge of the signal.

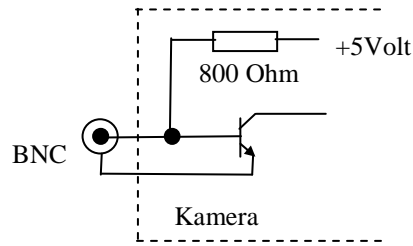

Figure 5: Synchronisation Input, schematical presentation

Synchronisation Output

The synchronisation output gives out a TTL signal synchronous to the frame rate of the camera. The positive edge is synchronous to the beginning of the exposure time of each frame.

Output Impedance: 50 Ohm.

Signal Level: approx. 4 Volt into high impedance (> 500Ohm)
approx. 2 Volt into 50 Ohm

Example for high impedance termination:

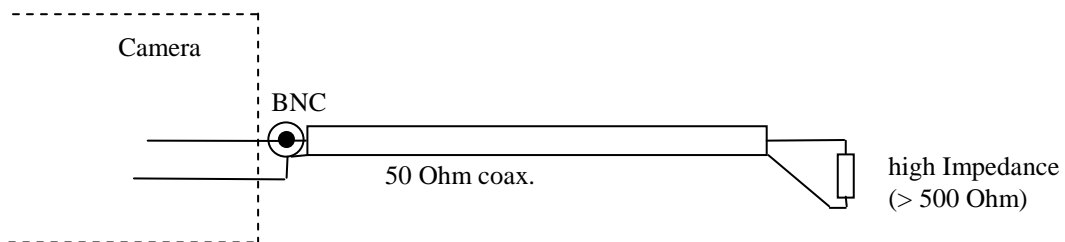

Example for 50 Ohm termination:

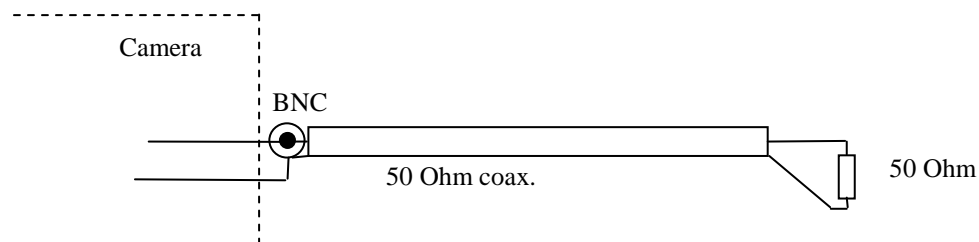

AccuPack (/BI)

Camera Backside

The standard backside of the CR camera don't offers mounting possibilities.

With the camera option /BI (Accupack) the camera offers special mounting facility for a Lilon Accupack with charger.



Camera backside with /BI Option



CR Kamera with mounted AccuPack

Install AccuPack

The AccuPack contains separate charger and LiIon Accumulator. To mount the AccuPack please mount first the charger on the backside of the camera and shift the charger in its locking position (step 1 to 3).

Then please mount the Lilon Accu accordingly and shift it in it's locking position (step 4 to 5).

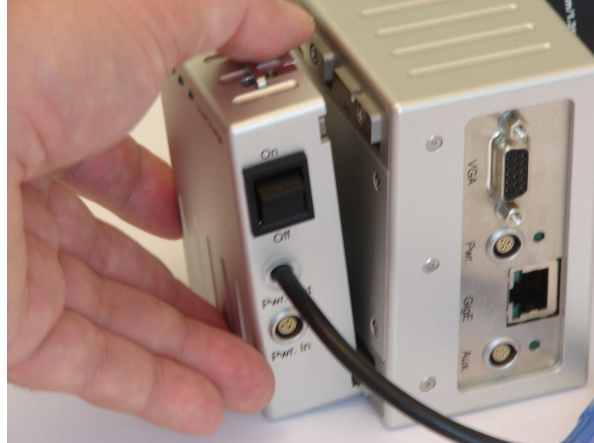

Step 1: Attach Charger to backside



Step 2: Push Charger to backside

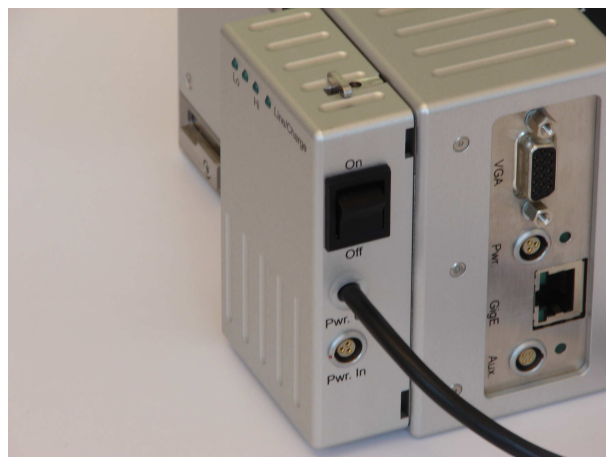

Step 3: Shift Charger into locking position



Step 4: Attach Lilon Accumulator and push to backside



Step 5: Shift Accumulator to the right into locking position



Schritt 6: Switch should be in positioned in „off“ state, connect camera and AccuPack

Schritt 7: Connect 12 Volt power source with AccuPack

Change Accumulator, Unconnect Charger

Unlock the Accumulator and shift the accumulator to the left (Step 8 to Step 9)

The Charger can then be disconnected accordingly

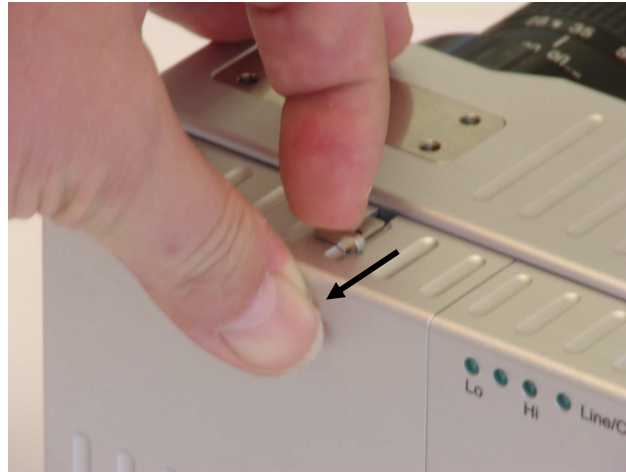

Step 8: Unlock Accumulator ...



Step 9: ... and shift Accumulator to the left

Important Hints



Never connect the Power Output of the AccuPack to the Power Input of the AccuPack. Voltage levels that may arise may damage the charger.



For highest safety please unconnect the Accumulator before transportation of the camera.



Please make sure, that the electrical pins of the accumulator can not be short-circuited during transportation.

Operation



The three LEDs on the left show the charging state at the connected Accumulator.

During Charging all three LEDs show the charging state.

Indication	Charging state
Left „Lo“ LED	Accu charges
Left „Lo“ and Middle LED	Accu charges
Left „Lo“, Middle, and Right „Hi“ LED	High, Charging process finished

During Discharge, only both left LEDs show Discharge state.

Indication	Discharge State
Left „Lo“ LED	Low (< 25% remaining charge)
Left „Lo“ and Middle LED	High (>25% remaining charge)



The Line/Charge LED shows, at connected accumulator, that the accumulator is charging, and that an external 12 Volt power supply is connected.

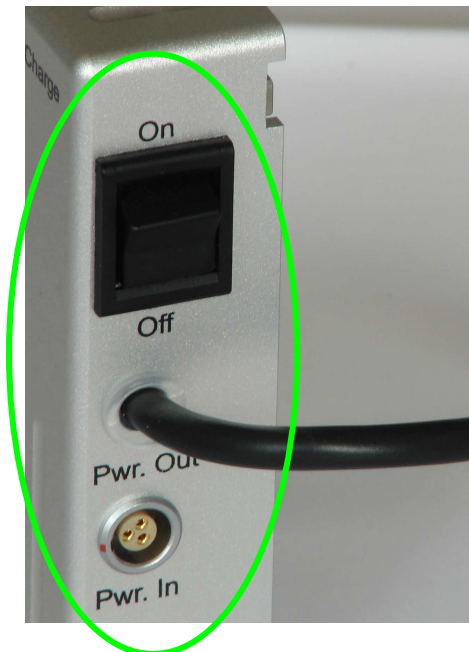

Configuration	Operation mode
Switch „On“ Pwr. Out connected to the camera Pwr. In connected to 12 Volt Power Supply	Camera switched on, Accu charges
Switch „Off“ Pwr. Out connected to the camera Pwr. In connected to 12 Volt Power	Camera switched off Accu charges
Switch „On“ Pwr. Out connected to the camera Pwr. In not connected	Camera switched on Accu discharges
Switch „Off“ Pwr. Out connected to the camera Pwr. In not connected	Camera switched off Accu keeps its charge

Power Supply

The power supply accepts 110 to 220 Volt input voltage at an input frequency of 50 to 60 Hz. It transforms this voltage to 12 Volt dc with a precision of better +/- 5%.

Remark:

If the camera isn't used over a long time interval, the 110 to 220 Volt power supply should be disconnected. This may increase the life time of the power supply.

Laptop (PC)

The Laptop or PC should have the following min. configuration:

- CamControl Software:
 - Gigabit Ethernet (GigE) interface
 - Intel or AMD processor
 - min. 1GByte RAM
 - Large Harddisk (e.g. 500 GBytes)
 - Windows 2000
 - Windows XP (32 bit or 64 bit)
 - or Windows VISTA (32 bit or 64 bit)
- TimeBench Software:
 - Windows XP/Vista/7
 - "Multi Core" Processor (e.g. Pentium Dual Core)
 - Large Harddisk (e.g. 500 GBytes)
 - A modern high-performant graphic card (e.g. 256 Mbytes) with minimum Direct X9 capability
 - A licensed digital CR series camera

For optimum performance and best display on the monitor we recommend to use highest-performance graphic boards.

Remark:

The CamRecord CR600x2, CR4000x2 cameras will provide image data with 8bit (256 grey levels) or 10 bit resolution (1024 grey-levels).

The CR450x2, CR1000x2, CR3000x2 and CR5000x2 provide image data with 8 bit resolution (256 grey levels).

However the monitor allows only to display black/white images in 8 bit resolution (256 grey levels). Color display with color cameras has 24 Bit resolution (3x8Bit, 16,7 million colors).

Consequently please make sure, that for color cameras the computer monitor allows to display 16,7 million colors.

CamControl Software

The standard CamControl software can be used to operate up to 16 CamRecord CR cameras in an application window. The CamControl Software supports CR450x2, CR600x2, CR1000x2, CR4000x2 and CR5000x2. Please look in the CamControl Software user manual for the actual software feature list.

TimeBench Software

The standard TimeBench software can be used to operate multiple CamRecord CR cameras in an application window and will offer additional features compared to the CamControl software. The TimeBench Software supports CR450x2 (x3), CR600x2, CR1000x2 (x3), CR3000x2 CR4000x2 and CR5000x2. Please look in the TimeBench Software user manual for the actual software feature list.

Technical Data

CR450x2

Full Resolution (h x v)	800 x 600 Pixel
Pixel Size	14 x 14 μm^2
Frame Size (h x v) at full resolution	11,2 x 8,4 mm ²
Frame Diagonal at full resolution	17,72 mm
Sensor dynamics	48 dB electrical (Linear) Up to 90 dB optical (Multislope)
Ambient Temperature	0°C - 40°C
Humidity	< 80% relative, non-condensed
Weight	1050 g (without lens)
Power Source	12Volt +/- 5% 2,5 Amp. < 100mV ripple
Power	approx. 12W
Interface	GigE (Gigabit-Ethernet)

Spectral Response / Transmittance

Spectral response (Monochrome Sensor)

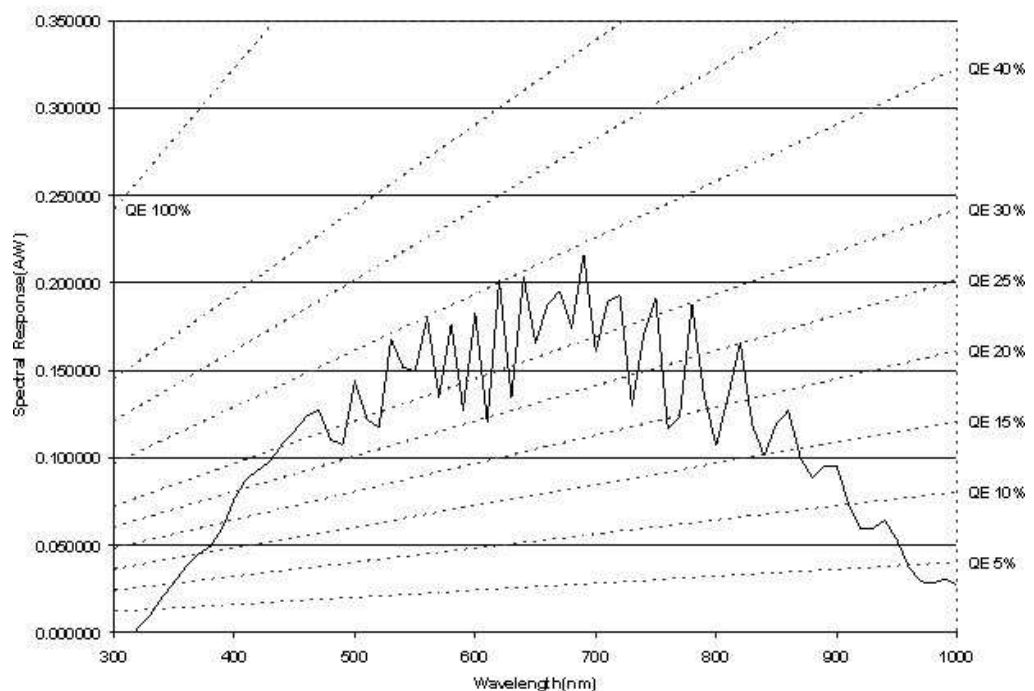

Transmittance (Color Sensor / IR Cutoff Filter)

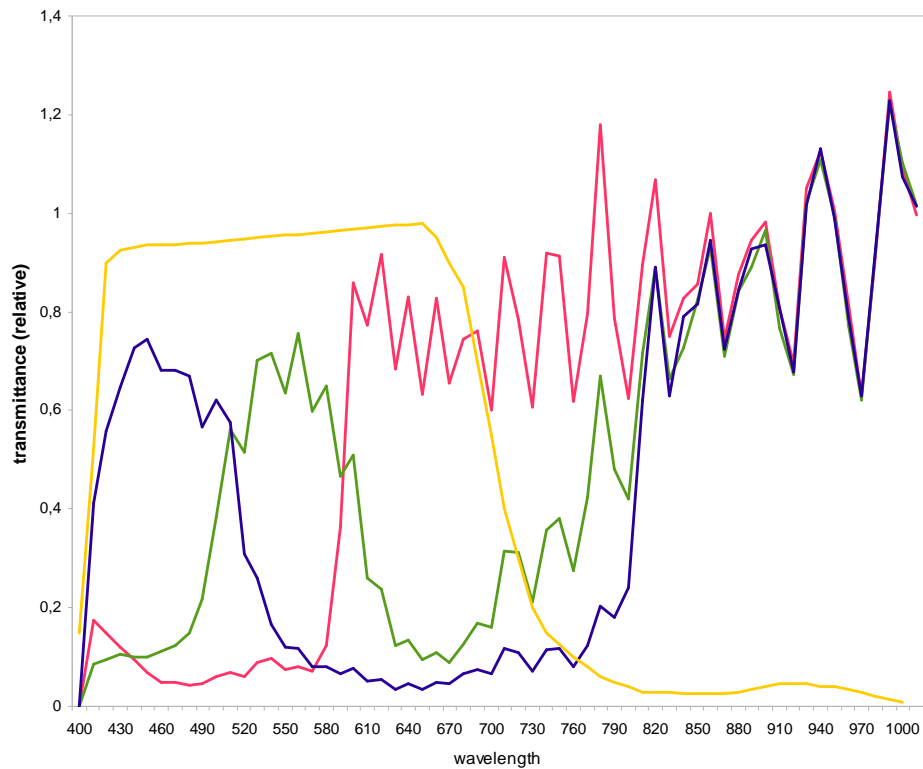

RGB Pixels (red, green, blue),
 IR Cutoff Filter characteristics (orange), Filter Specification: 1830-SS-10

Bayer Pattern

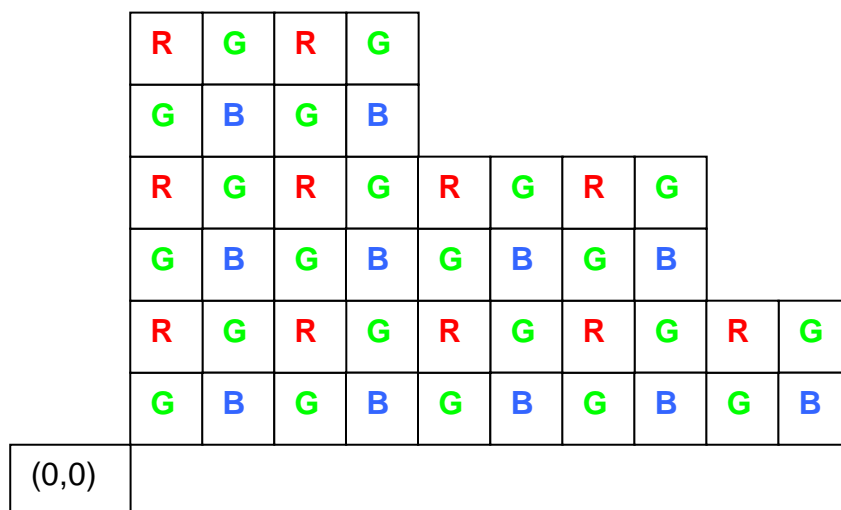

Figure: Bayer Pattern of the Color Sensor

CR450x3

Full Resolution (h x v)	1024 x 1024 Pixel
Pixel Size	14 x 14 μm^2
Frame Size (h x v) at full resolution	14,336 x 14,336 mm ²
Frame Diagonal at full resolution	20,274 mm
Sensor dynamics	48 dB electrical (Linear) Up to 90 dB optical (Multislope)
Ambient Temperature	0°C - 40°C
Humidity	< 80% relative, non-condensed
Weight	1050 g (without lens)
Power Source	12Volt +/- 5% 2,5 Amp. < 100mV ripple
Power	approx. 12W
Interface	GigE (Gigabit-Ethernet)

Spectral Response / Transmittance

Spectral response (Monochrome Sensor)

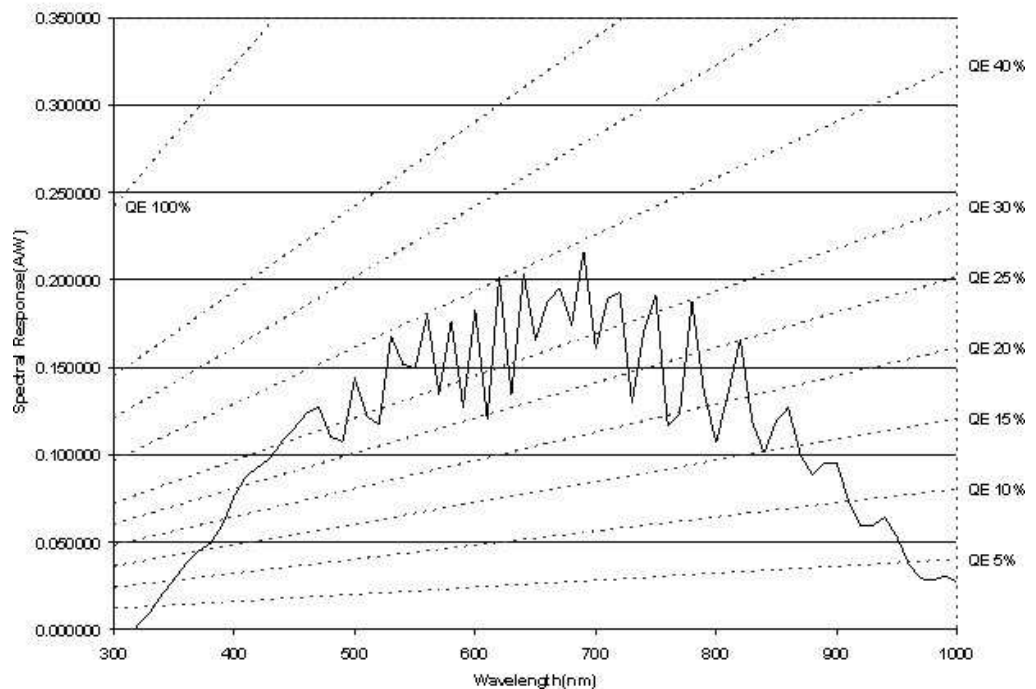

Transmittance (Color Sensor / IR Cutoff Filter)

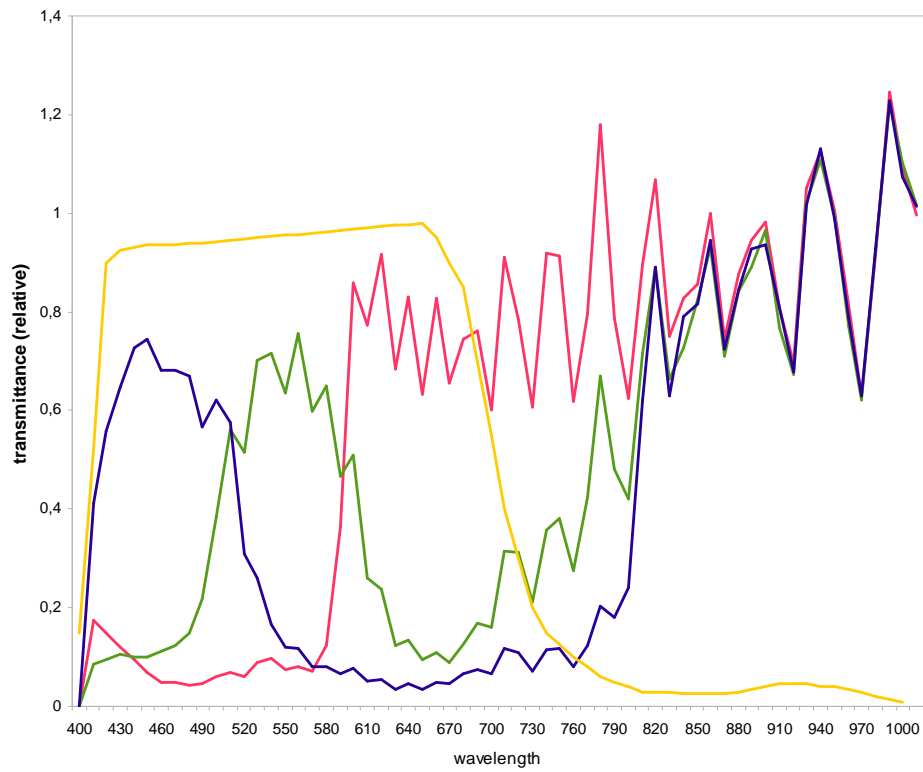

RGB Pixels (red, green, blue),
 IR Cutoff Filter characteristics (orange), Filter Specification: 1830-SS-10

Bayer Pattern

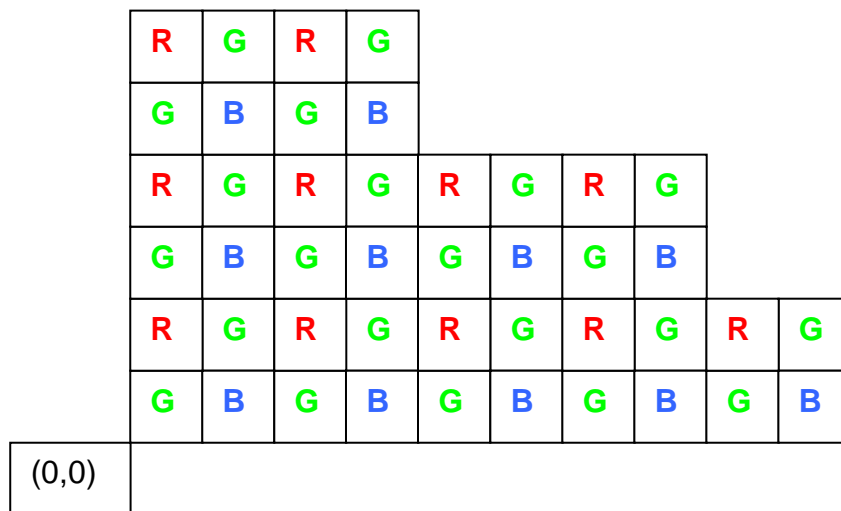

Figure: Bayer Pattern of the Color Sensor

CR600x2

Full Resolution (h x v)	1280 x 1024 Pixel
Pixel Size	14 x 14 μm^2
Frame Size (h x v) at full resolution	17,92 x 14,34 mm ²
Frame Diagonal at full resolution	22,95 mm
Sensor responsivity	25 V/lux.sec
Sensor dynamics	58 dB electrical (Linear) Up to 90 dB optical (Multislope)
Shutter Type	global
Ambient Temperature	0°C - 40°C
Humidity	< 80% relative, non-condensed
Weight	1050 g (without lens)
Power Source	12Volt +/- 5% 2,5 Amp. < 100mV ripple
Power	approx. 12W
Interface	GigE (Gigabit-Ethernet)

Spectral Response / Transmittance

Spectral response (Monochrome Sensor)

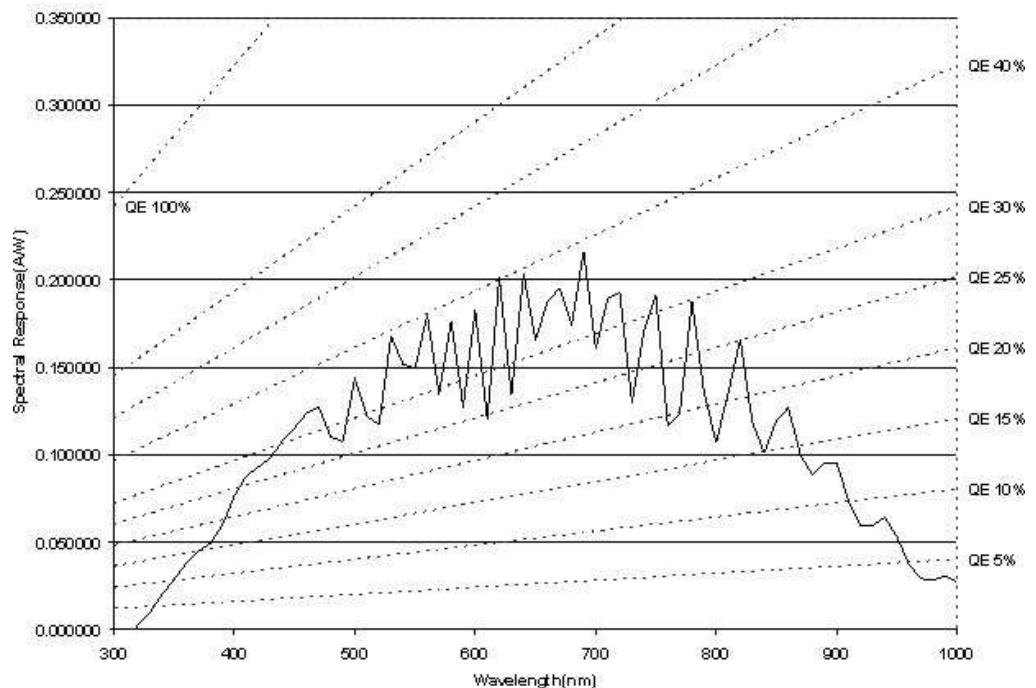

Transmittance (Color Sensor / IR Cutoff Filter)

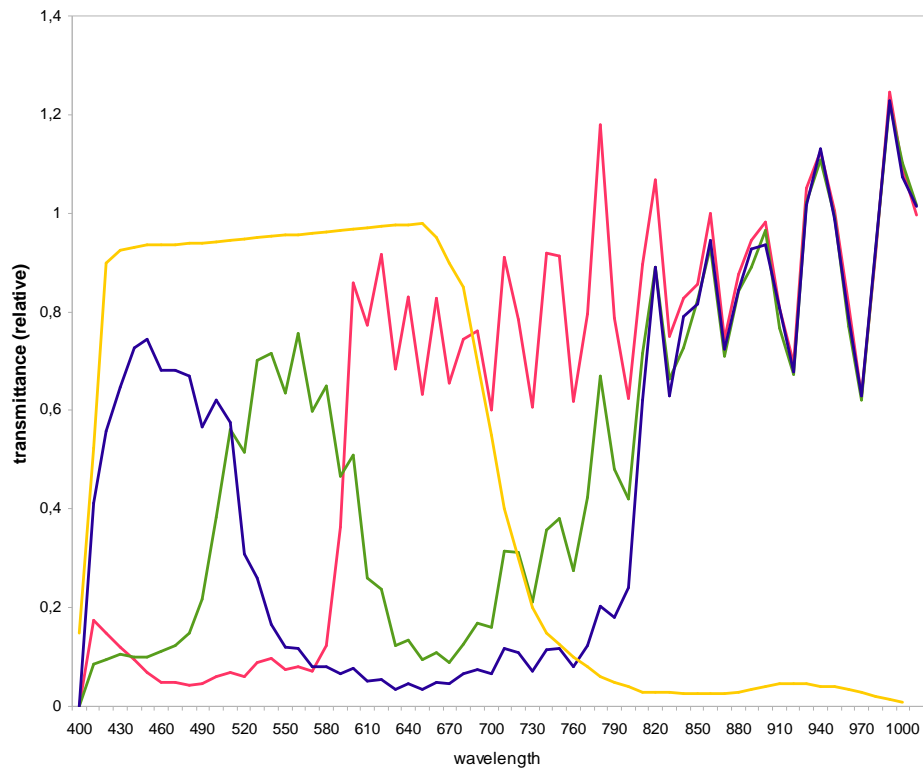

RGB Pixels (red, green, blue),
 IR Cutoff Filter characteristics (orange), Filter Specification: 1830-SS-10

Bayer Pattern

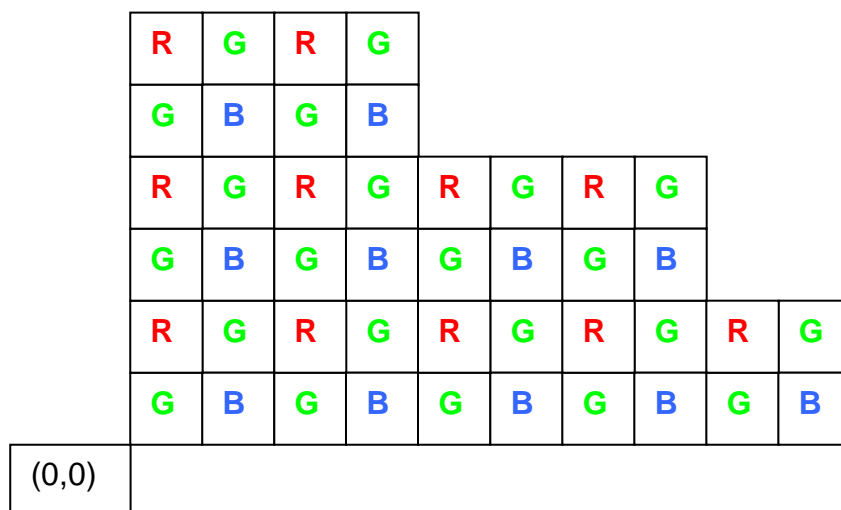

Figure: Bayer Pattern of the Color Sensor

CR1000x2

Full Resolution (h x v)	1280 x 1024 Pixel
Pixel Size	12 x 12 μm^2
Frame Size (h x v) at full resolution	15,36 x 12,29 mm ²
Frame Diagonal at full resolution	19,67 mm
Full Well Capacity	63000 e-
Noise Contribution	70 e-
Fill Factor	40 %
Responsivity	1600 LSB/(Lux sec)
Dynamics	48 dB (SNR > 44dB)
Dark Noise Temperature Coefficient	100% / 8°C
Shutter Type	Global
Shutter Efficiency	> 99,9 %
Humidity	< 80% relative, non-condensed
Weight	1050 g (without lens)
Power Source	12Volt +/- 5% 2,5 Amp. < 100mV ripple
Power	approx. 12W
Interface	GigE (Gigabit-Ethernet)

Spectral Response / Transmittance

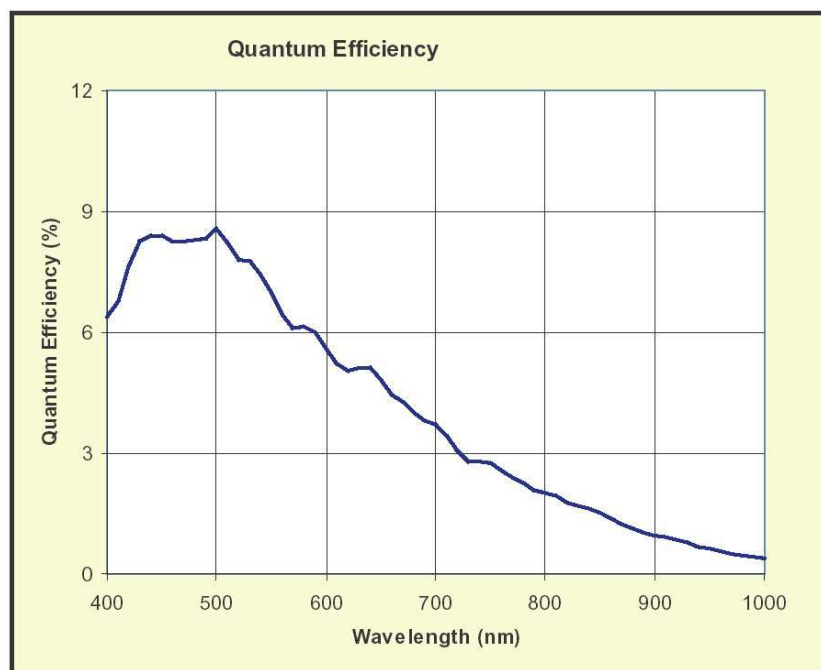

Figure : Quantum Efficiency Black/White-Sensor

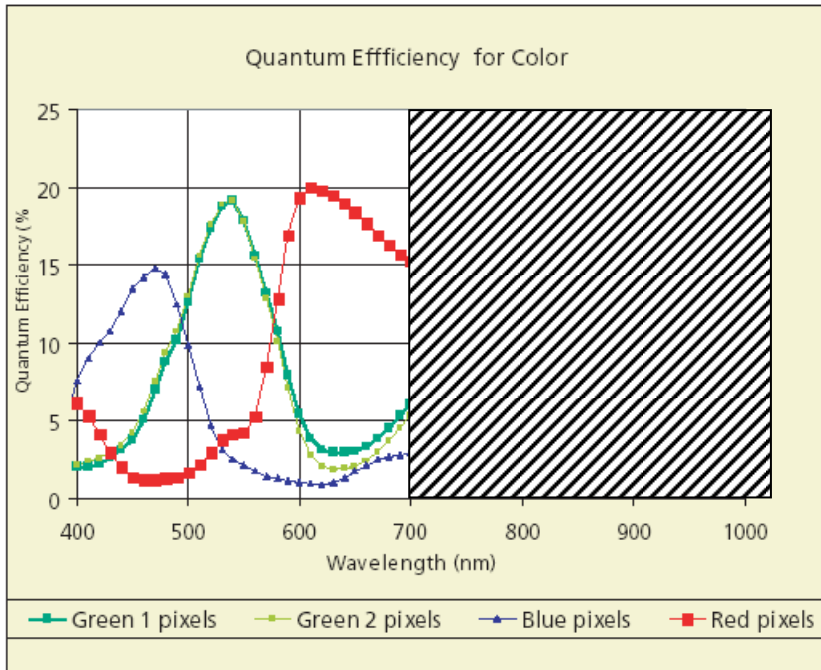

Figure: Quantum Efficiency for Color Sensor (relative values)

Remark:

The color camera consist of an infrared filter which blocks light beyond ~ 700 nm as illustrated in the figure.

IR Cutoff Filter characteristics see CR450x2, Filter Specification: 1830-SS-10

Bayer Pattern

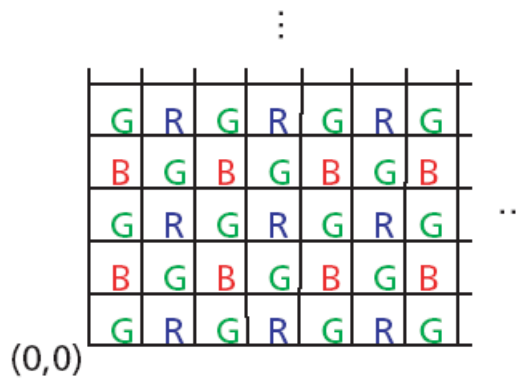

Figure: Bayer Pattern Arrangement on Color Sensor

CR3000x2

Full Resolution (h x v)	1696 x 1710 Pixel
Pixel Size	8 x 8 μm^2
Frame Size (h x v) at full resolution	13,57 x 13,68 mm ²
Frame Diagonal at full resolution	19,27 mm
Responsivity	3,8 V/(Lux sec) @ Monochrom
Dynamics	8bit (electrical)
Dark Noise Temperature Coefficient	100% / 8°C
Shutter Type	Global
Shutter Efficiency	99,9 %
Humidity	< 80% relative, non-condensed
Weight	1050 g (without lens)
Power Source	12Volt +/- 5% 2,5 Amp. < 100mV ripple
Power	approx. 12W
Interface	GigE (Gigabit-Ethernet)

Spectral Response / Transmittance

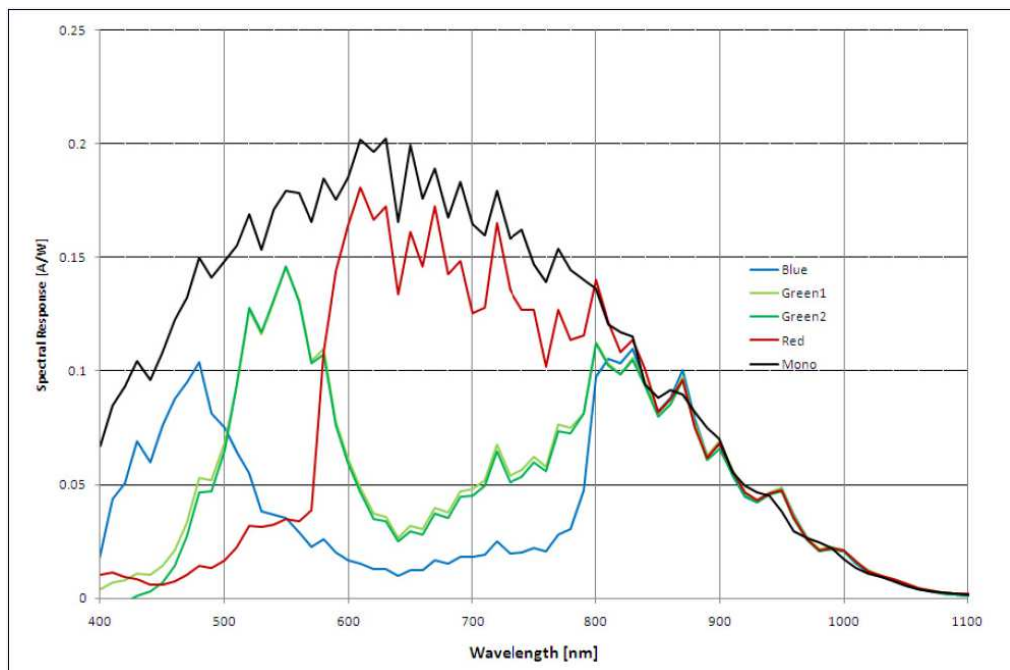

Figure : Quantum Efficiency Black/White and Color-Sensor

Remark:

The color camera consist of an infrared filter which blocks light beyond ~ 700 nm as illustrated in the figure.

IR Cutoff Filter characteristics see CR450x2, Filter Specification: 1830-SS-10

CR1000x3

Full Resolution (h x v)	1280 x 1024 Pixel
Pixel Size	8 x 8 μm^2
Frame Size (h x v) at full resolution	10,24 x 8,192 mm ²
Frame Diagonal at full resolution	13,113 mm
Responsivity	3,8 V/(Lux sec) @ Monochrom
Dynamics	8bit (electrical)
Dark Noise Temperature Coefficient	100% / 8°C
Shutter Type	Global
Shutter Efficiency	99,9 %
Humidity	< 80% relative, non-condensed
Weight	1050 g (without lens)
Power Source	12Volt +/- 5% 2,5 Amp. < 100mV ripple
Power	approx. 12W
Interface	GigE (Gigabit-Ethernet)

Spectral Response / Transmittance

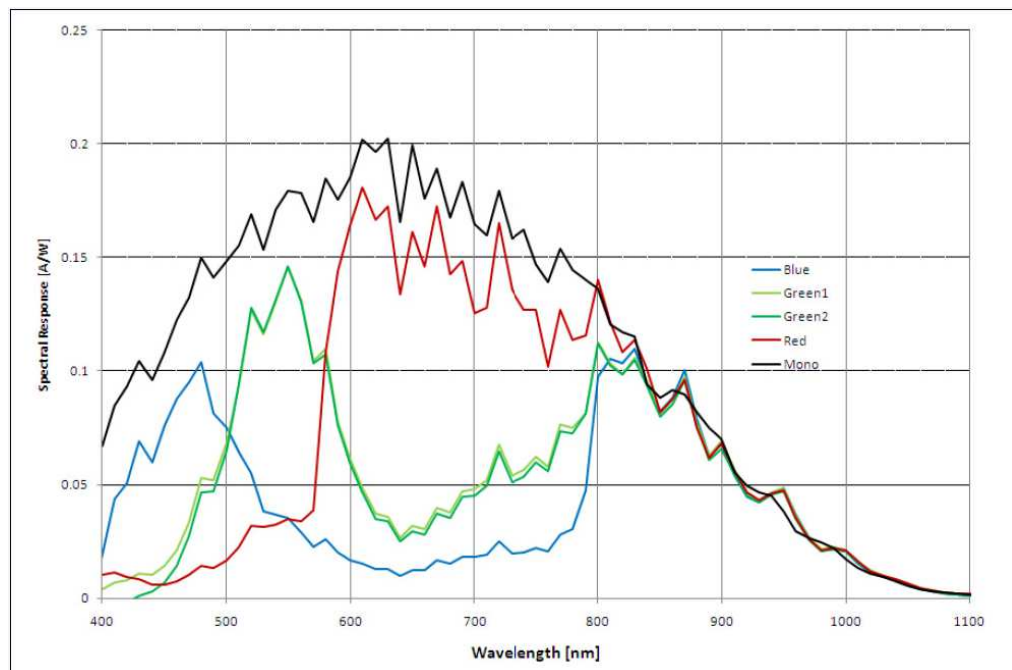

Figure : Quantum Efficiency Black/White and Color-Sensor

Remark:

The color camera consist of an infrared filter which blocks light beyond ~ 700 nm as illustrated in the figure.

IR Cutoff Filter characteristics see CR450x2, Filter Specification: 1830-SS-10

CR4000x2

Full Resolution (h x v)	2304 x 1720 Pixel
Pixel Size	7 x 7 μm^2
Frame Size (h x v) at full resolution	16,128 x 12,04 mm ²
Frame Diagonal at full resolution	20,126 mm
Full Well Capacity	16000 e-
Noise Contribution	22 e-
Fill Factor	- %
Responsivity	9000 LSB/(Lux sec) @550nm
Dynamics	60 dB / 10bit (electrical)
Dark Noise Temperature Coefficient	100% / 8°C
Shutter Type	Global
Shutter Efficiency	99,9 %
Humidity	< 80% relative, non-condensed
Weight	1050 g (without lens)
Power Source	12Volt +/- 5% 2,5 Amp. < 100mV ripple
Power	approx. 12W
Interface	GigE (Gigabit-Ethernet)

Spectral Response / Transmittance

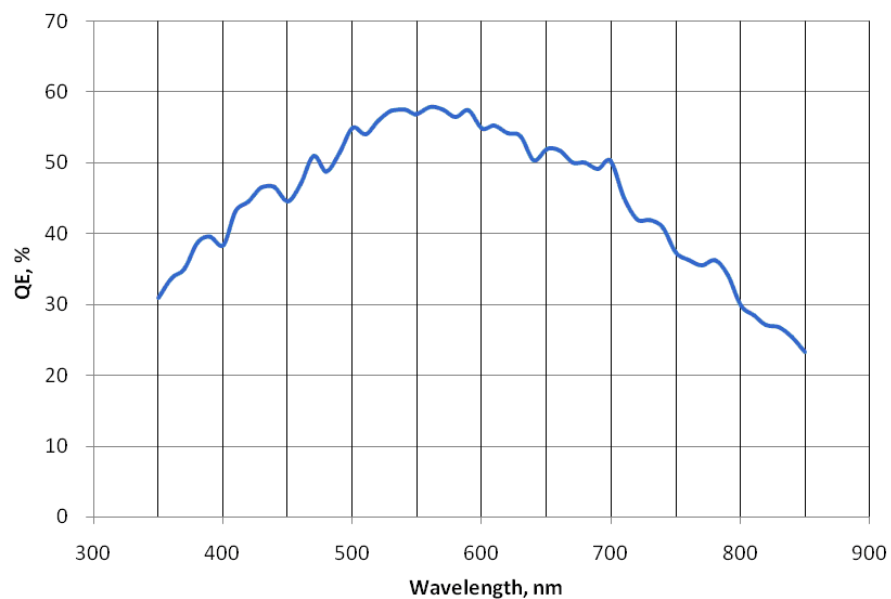

Figure : Quantum Efficiency Black/White-Sensor

Remark:

The color camera consist of an infrared filter which blocks light beyond ~ 700 nm as illustrated in the figure.

IR Cutoff Filter characteristics see CR450x2, Filter Specification: 1830-SS-10

CR5000x2

Full Resolution (h x v)	512 x 512 Pixel
Pixel Size	16 x 16 μm^2
Frame Size (h x v) at full resolution	8,19 x 8,19 mm^2
Frame Diagonal at full resolution	11,58 mm
Full Well Capacity	60000 e-
Noise Contribution	70 e-
Fill Factor	62 %
Responsivity	9 V/(Lux sec)
Dynamics	59 dB internal (SNR > 44dB)
Dark Noise Temperature Coefficient	100% / 8°C
Shutter Type	global
Shutter Efficiency	> 99 %
Humidity	< 80% relative, non-condensed
Weight	1050 g (without lens)
Power Source	12Volt +/- 5% 2,5 Amp. < 100mV ripple
Power	approx. 12W
Interface	GigE (Gigabit-Ethernet)

Spectral Response / Transmittance

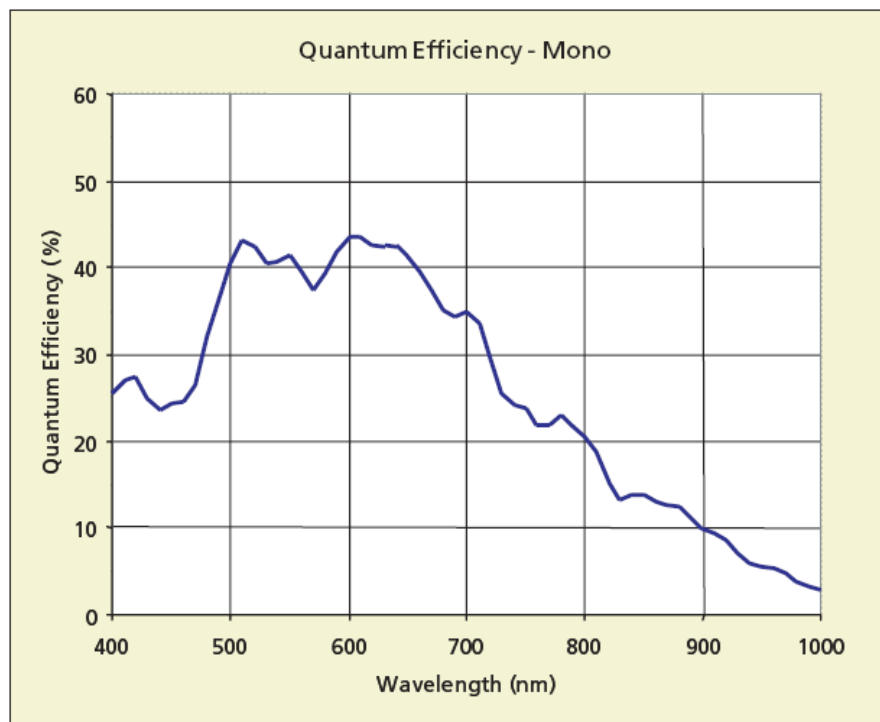

Figure : Quantum Efficiency Black/White-Sensor

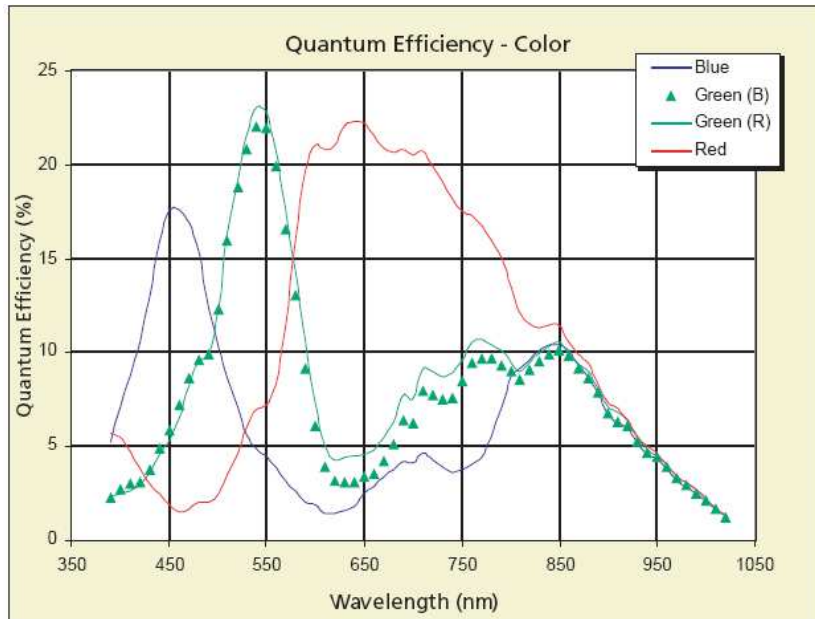

Figure: Quantum Efficiency for Color Sensor

Remark:

The color camera consist of an infrared filter which blocks light beyond ~ 700 nm as illustrated in the figure.

IR Cutoff Filter characteristics see CR450x2, Filter Specification: 1830-SS-10

Bayer Pattern

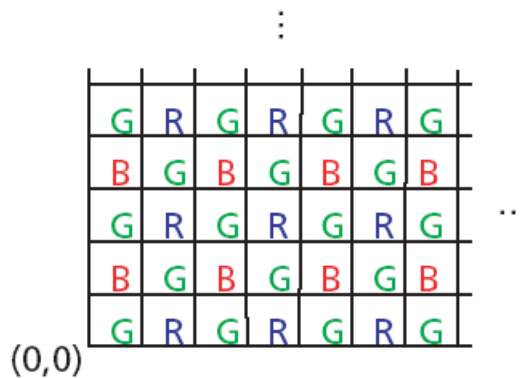

Figure: Bayer Pattern Arrangement on Color Sensor

AccuPack (/BI)

Techology	Lilon
Charging Time	~ 7h to full charge
Full Charge	> 90 min operation Depending on CR series camera model @ full operation
Humidity	< 80% relative, non-condensed
Weight	150 g Charger 350 g Accumulator
Power Source (Pwr. In)	12Volt +/- 5% 2,5 Amp. < 100mV ripple
Power	approx. 5 W
Dimension (H x W x D)	90mm x 55mm x 25mm (charger) 90mm x 90mm x 25mm (Accumulator)

Performance (Examples)

CR450x2

Speed	Resolution (h x v)	Video Memory: /16GB Recording Time @ max. Speed	Exposure Time @ max. Speed
20 .. 1000 Images/s	800 x 600	32 s	1 μ s .. 1 ms
20 .. 2000 Images/s	600 x 400	32 s	1 μ s .. 500 μ s

CR450x3

Speed	Resolution (h x v)	Video Memory: /16GB Recording Time @ max. Speed	Exposure Time @ max. Speed
20 .. 300 Images/s	1024 x 1024	52 s	1 μ s .. 3,3 ms
20 .. 500 Images/s	1024 x 768	42 s	1 μ s .. 2 ms
20 .. 1000 Images/s	800 x 600	35 s	1 μ s .. 1ms
20 .. 2000 Images/s	600 x 400	34 s	1 μ s .. 500 μ s
20 ..5000 Images/s	320 x 200	51 s	1 μ s .. 200 μ s

CR600x2

Speed	Resolution (h x v)	Video Memory: /16GB Recording Time @ max. Speed	Exposure Time @ max. Speed
20 .. 500 Images/s	1280 x 1024	26 s	1 μ s .. 2 ms
20 .. 1200 Images/s	800 x 600	27 s	1 μ s .. 1 ms
20 .. 2000 Images/s	512 x 512	30 s	1 μ s .. 830 μ s
20 .. 6350 Images/s	256 x 256	36 s	1 μ s .. 800 μ s
20 ..16000 Images/s	128 x 128	58 s	1 μ s .. 520 μ s

- Resolution x2 (software blow-up) with UltraFormat Option

CR1000x2

Speed	Resolution (h x v)	Video Memory: /16GB Recording Time @ max. Speed	Exposure Time @ max. Speed
50 .. 1000 Images/s	1280 x 1024	12 s	1 μ s .. 1 ms
50 .. 2000 Images/s	512 x 512	30 s	1 μ s .. 500 μ s
50 .. 4000 Images/s	256 x 256	61 s	1 μ s .. 250 μ s
50 ..8000 Images/s	128 x 128	122 s	1 μ s .. 125 μ s

- Resolution x2 (software blow-up) with UltraFormat Option
- Speed up to x2 with UltraSpeed Option (depending on exposure time), only monochrome sensor

CR1000x3

Speed	Resolution (h x v)	Video Memory: /16GB Recording Time @ max. Speed	Exposure Time @ max. Speed
50 .. 1000 Images/s	1280 x 1024	13 s	2 μ s .. 1 ms
50 .. 2000 Images/s	800 x 600	17 s	2 μ s .. 500 μ s
50 .. 4000 Images/s	600 x 400	17 s	2 μ s .. 250 μ s
50 ..8000 Images/s	384 x 256	21 s	2 μ s .. 125 μ s

CR3000x2

Speed	Resolution (h x v)	Video Memory: /8GB Recording Time @ max. Speed	Exposure Time @ max. Speed
50 .. 540 Images/s	1696 x 1710	5,5 s	2 μ s .. 1,85 ms
50 .. 1000 Images /s	1200 x 1200	5,8 s	2 μ s .. 1ms
50 .. 2000 Images /s	860 x 800	5,9 s	2 μ s .. 0,5ms
50 ..100000 Images /s	96 x 38	23,1 s	2 μ s .. 10 μ s

- Resolution x2 (software blow-up) with UltraFormat Option

CR4000x2

Speed	Resolution (h x v)	Video Memory: /8GB Recording Time @ max. Speed	Exposure Time @ max. Speed
50 .. 500 Images/s	2304 x 1720	4 s	2 μ s .. 2 ms
50 .. 560 Images /s	2048 x 1536	4,5 s	2 μ s .. 1,78 μ s
50 .. 750 Images /s	2048 x 1152	4,5 s	2 μ s .. 1,33ms
50 ..800 Images /s	1920 x 1080	4,5 s	2 μ s .. 1,25ms

- Resolution x2 (software blow-up) with UltraFormat Option
- Speed up to x2 with UltraSpeed Option (depending on exposure time), only monochrome sensor

CR5000x2

Speed	Resolution (h x v)	Video Memory: /16GB Recording Time @ max. Speed	Exposure Time @ max. Speed
50 .. 5000 Images/s	512 x 512	12,8 s	1 μ s .. 200 μ s
50 .. 10000 Images/s	512 x 256 256 x 256	12,8 s 25,6 s	1 μ s .. 100 μ s
50 .. 20000 Images/s	512 x 128 128 x 128	12,8 s 51,2 s	1 μ s .. 50 μ s
50 .. 40000 Images/s	512 x 64 64 x 64	12,8 s 102,4 s	1 μ s .. 25 μ s

- Resolution x2 (software blow-up) with UltraFormat Option
- Speed up to x2 with UltraSpeed Option (depending on exposure time), only monochrome sensor

Mechanical Dimensions

CR Series (/FM, /FMG)

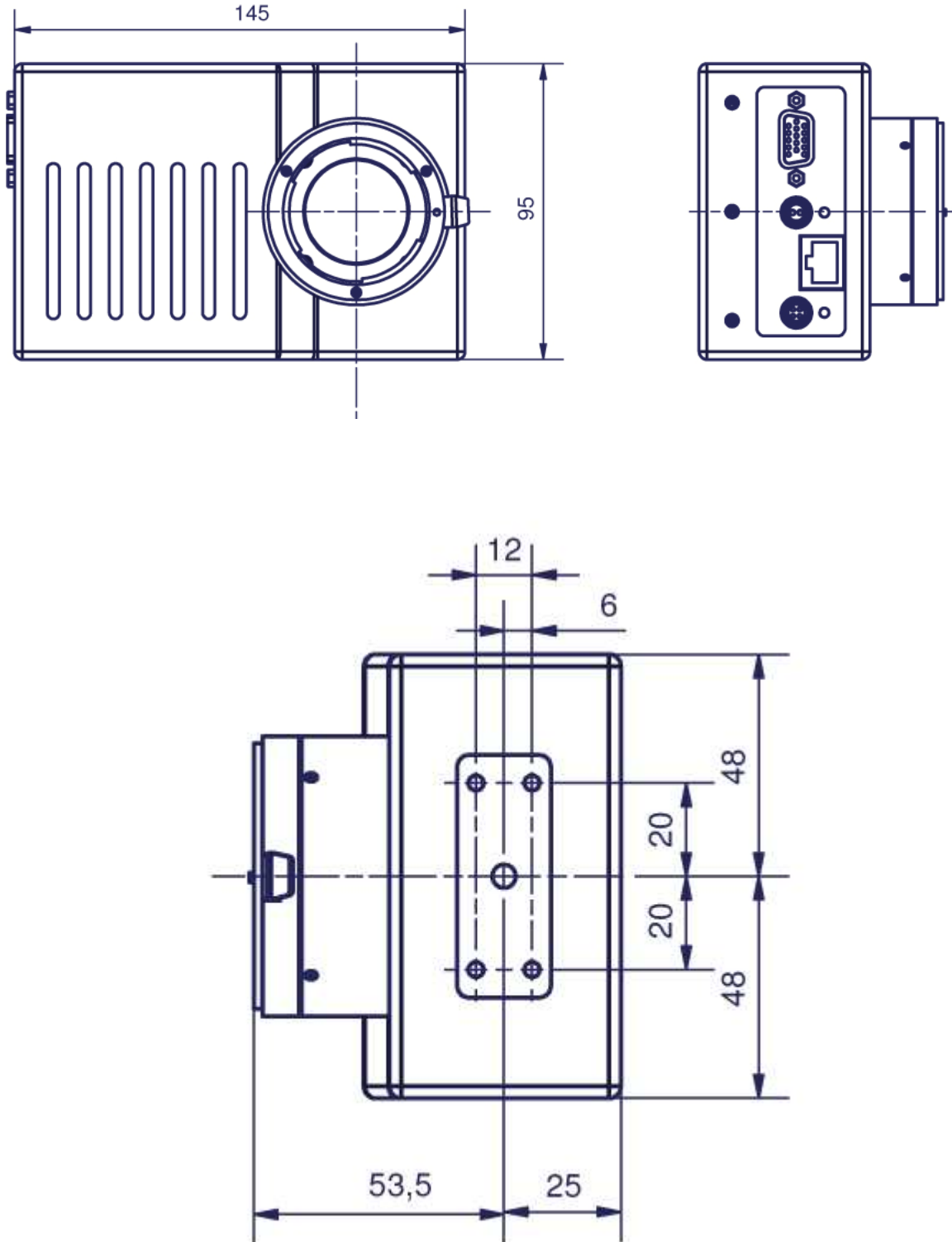

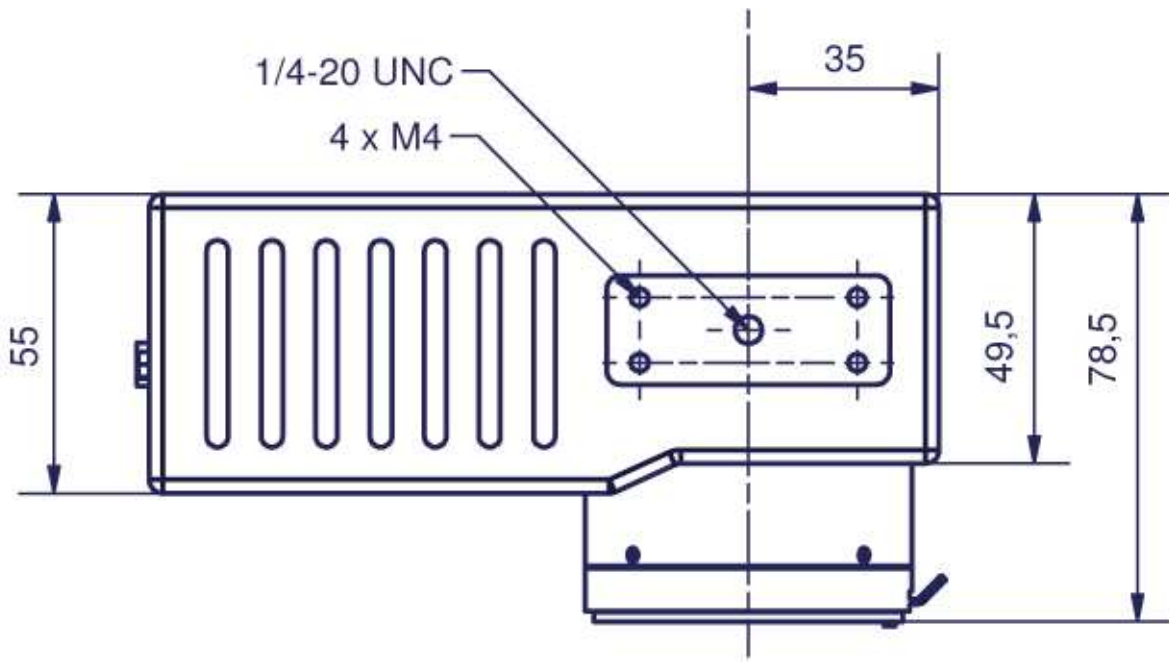

CR Series (/FM, /FMG, /BI)

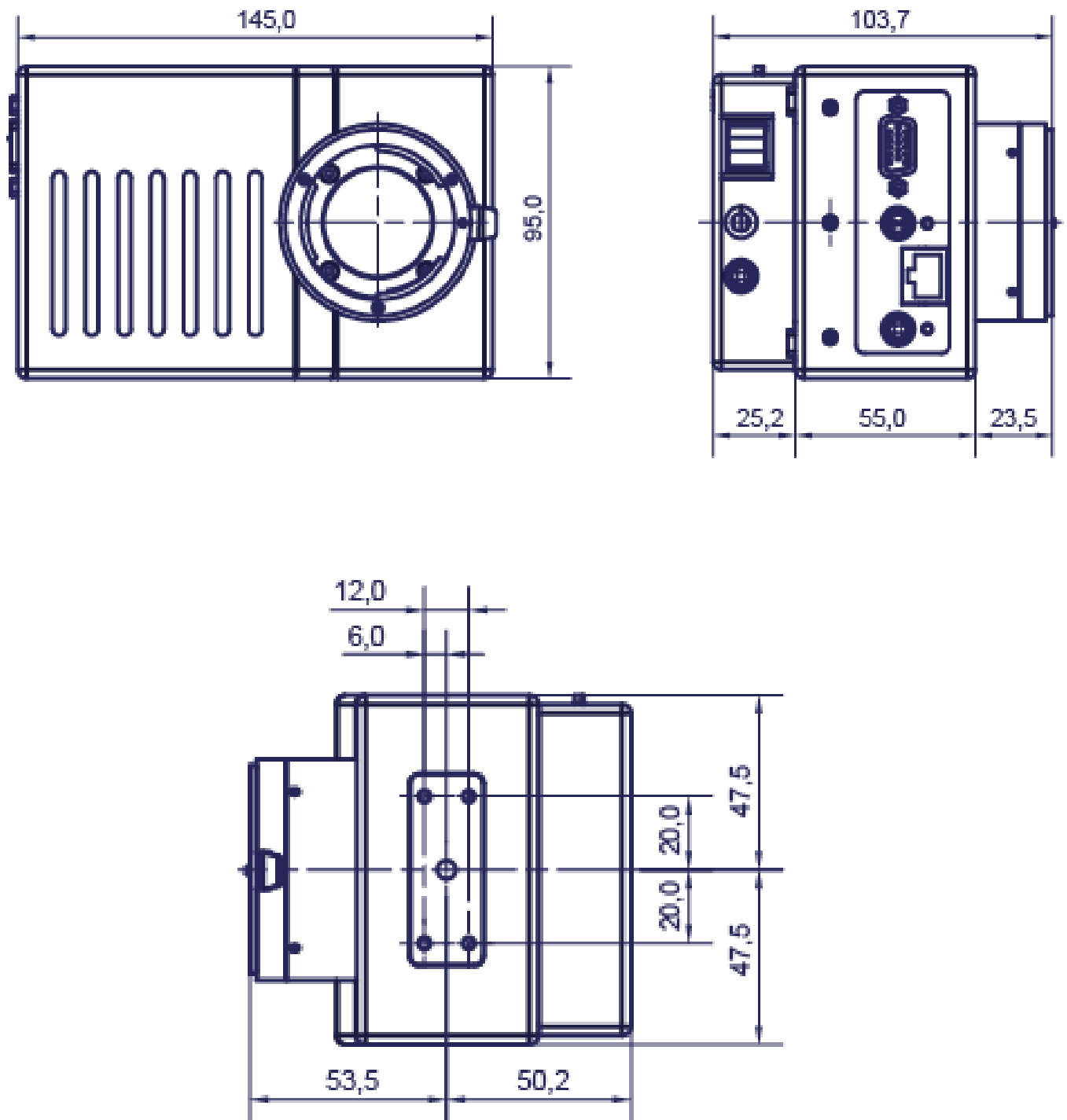

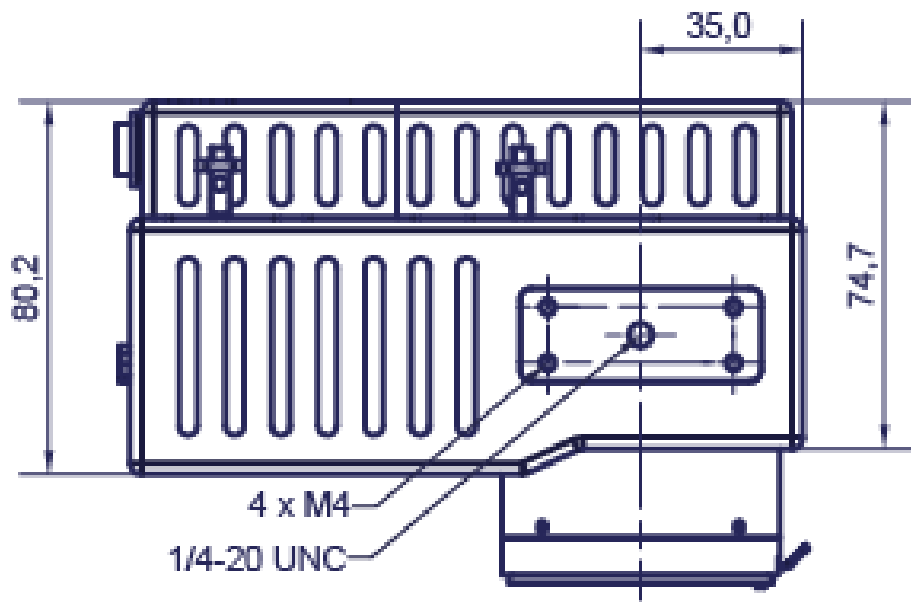

CR Series (/EM)

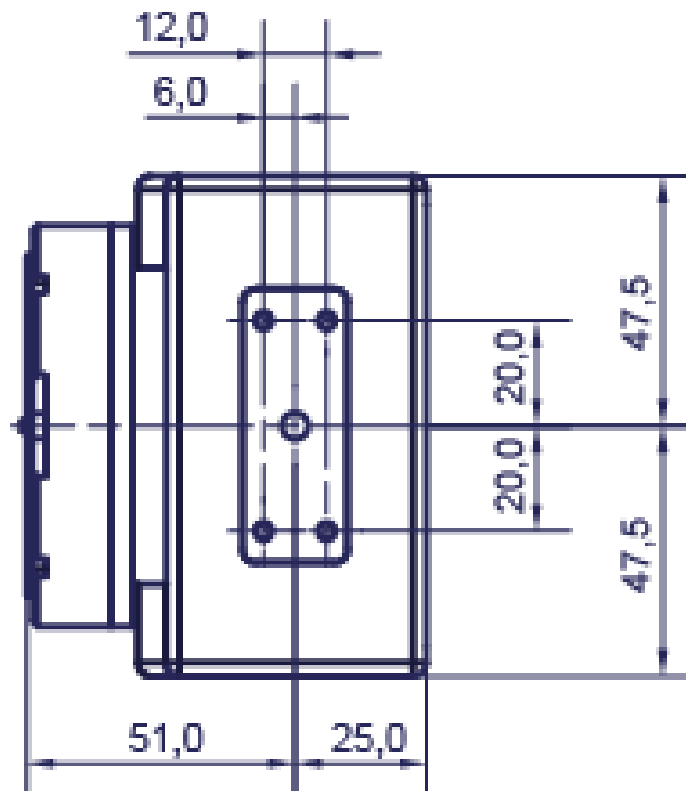
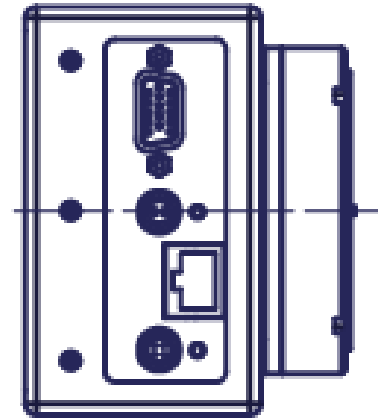
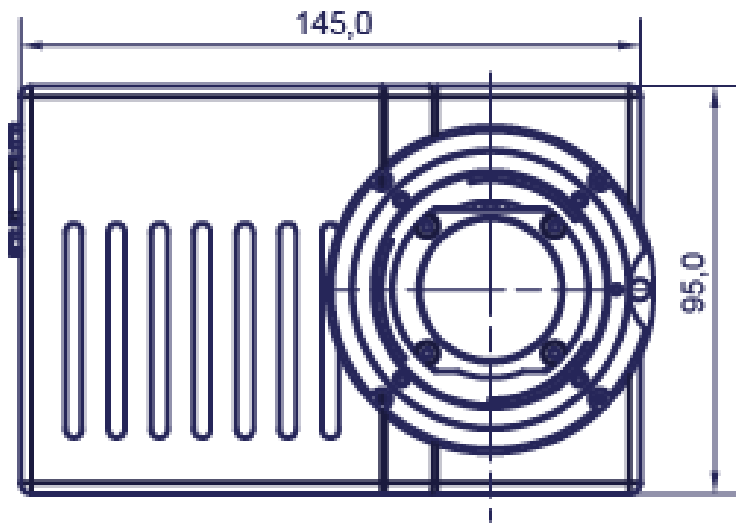

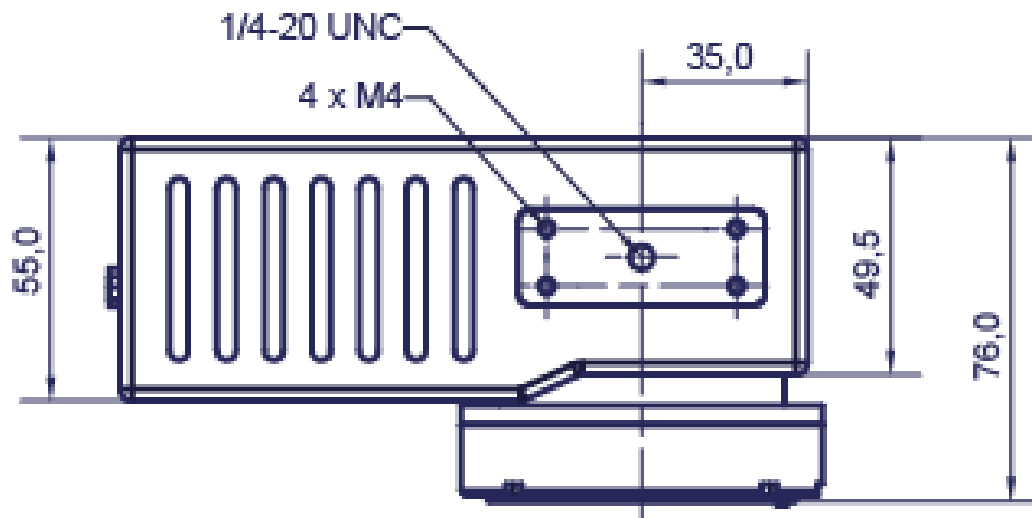

External Inputs

Trigger & Synchronisation input

Level	- TTL Low Level: < 0,8Volt High Level: > 2 Volt - external Switch or Open Colletor - edge triggered
maximum Input Level:	+ 24 Volt / - 10 Volt
Edge	Rising: (TTL) Falling: (Tigger on external switch or Open Collector)
Rise-Time	< 100 nsec
Input Impedance	high (~ 800 Ohm)

Synchronisation Timing

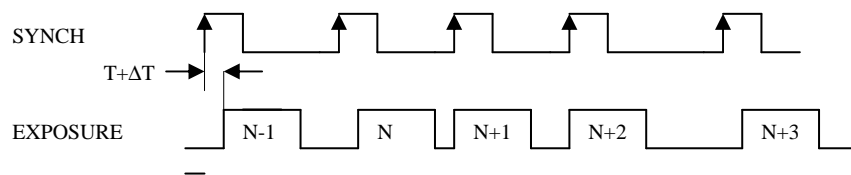

CR1000x2:

Delay (T): 1,135 μ sec

Jitter (ΔT): +/-567 nsec

resulting delay (T+ ΔT): 0,67 .. 1,6 μ sec

CR3000x2:

Delay (T): 2,7 μ sec

Jitter (ΔT): +/-500 nsec

resulting delay (T+ ΔT): 2,2 .. 3,2 μ sec

CR1000x3:

Delay (T): 2,7 μ sec

Jitter (ΔT): +/-500 nsec

resulting delay (T+ ΔT): 2,2 .. 3,2 μ sec

CR4000x2:

Delay (T): 0,88 μ sec
 Jitter (ΔT): +/-600 nsec
 resulting delay (T+ ΔT): 0,28 .. 1,48 μ sec

CR5000x2:

Delay (T): 535 nsec
 Jitter (ΔT): +/- 425 nsec

CR450x2 (x3), CR600x2:

Delay (T): 2,63 μ sec
 Jitter (ΔT): +/-530 nsec
 resulting delay (T+ ΔT): 2,1 .. 3,16 μ sec

Trigger Timing

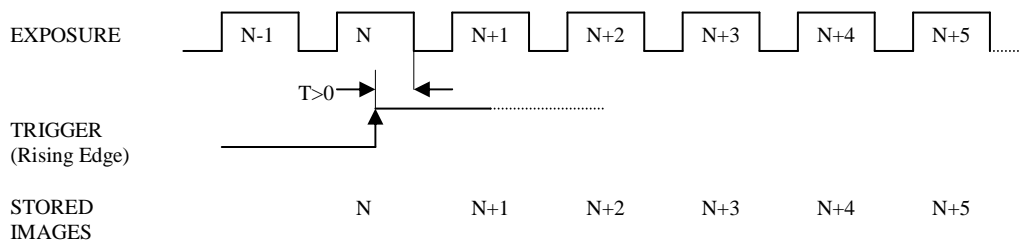

External Outputs

Synchronisation output

Level	TTL Low Level: < 0,8Volt High Level: 4 Volt typ. (into high Impedance) 2 Volt typ. (into 50 Ohm)
max. reverse Protection :	+ / - 10 Volt
Edge	Positive
Rise-Time	< 50 nsec

Synchronisation Timing

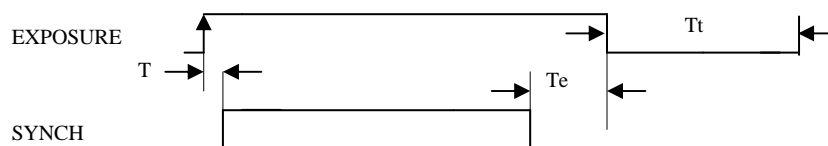

CR1000x2:

T: 100 nsec
Te: 220 nsec
Tt: min. 0

CR3000x2:

T: TBD
Te: TBD
Tt: min. 5 µsec

CR1000x3:

T: TBD
Te: TBD
Tt: min. 5 µsec

CR4000x2:

T: 84 nsec
Te: 94 nsec
Tt: min. 0

CR5000x2:

T: 90 nsec
Te: -90 nsec

Tt: min. 773 nsec

CR450x2, CR600x2:

T: 100 nsec

Te: -100 nsec

(Synch out high interval = Exposure high interval)

Tt: min. 0

T: Delay between the beginning of the exposure and beginning of Synch Output

Te: Time-interval between end of synch-signal and end of exposure-time

Tt: exposure dead time

Focal Length Calculation

CR450x2

Full Sensor Resolution

The required focal length of the lens at full sensor resolution (800 x 600 Pixel) is calculated as follows:

$$\text{Focal Length [mm]} = \frac{A}{1 + \frac{B}{17,7}}$$

A: Distance from lens to object in mm

B: Size of the object in mm

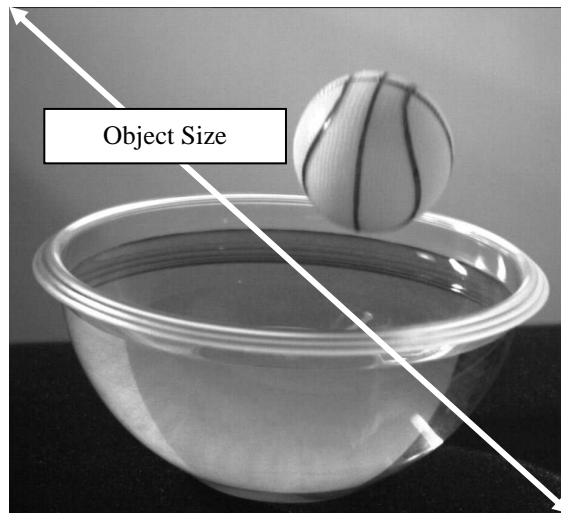

Example:

A: Distance from lens to object = 300 mm

B: Object Size = 100 mm

calculated focal length = $(300 : (1 + (100 : 17,7))) = 45$ mm

selected focal length = 35 mm

Reduced Sensor Resolution

At reduced sensor resolutions (e.g. 600 horizontal x 400 vertical pixels) the focal length is calculated as follows:

$$\text{Sensor Size [mm]} = 0,014 \cdot \sqrt{C^2 + D^2}$$

$$Focal\ Length\ [mm] = \frac{A}{1 + \frac{B}{Sensor\ Size\ [mm]}}$$

A: Distance from lens to object in mm

B: Object size in mm

C: Number of horizontal pixels

D: Number of vertical pixels

$$Sensor\ Size\ [mm] = 0,014 \cdot \sqrt{600^2 + 400^2} = 10,1$$

Example:

C: Number of horizontal pixels = 600

D: Number of vertical pixels = 400

A: Distance from lens to object = 300 mm

B: Object size = 100 mm

calculated focal length = $(300 : (1 + (100 : 10,1))) = 27,5$ mm

when a lens with focal length of 24 mm has to be used, and the object size has to be kept at 100 mm, the distance from lens to object has to be changed as follows:

$$Distance\ to\ Object\ [mm] = Focal\ Length \cdot \left(1 + \frac{Object\ Size}{Sensor\ Size} \right)$$

at a focal length of 24mm, an object size of 100mm and a sensor size of 10,1mm the new distance from lens to object is calculated as:

$$24 \cdot (1 + (100 : 10,1)) = 261\ mm$$

The distance from lens to object has to be reduced from 300mm to 261mm

Vice versa, when the distance from lens to object has to be reduced, the focus of the lens will come to its limit. and the required magnification factor

can no more performed by the lens itself. In this case, a distance washer has to be placed between the lens interface of the camera and the lens.

Distance Washer

The length of the distance washer can be calculated as follows:

$$\text{Length of the Distance Washer [mm]} = \text{Focal Length} \cdot \frac{\text{Sensor Size}}{\text{Object Size}}$$

Example:

Sensor Size as calculated above = 10,1mm

required Object Size=15mm

(The required magnification factor is = 1,5 : 1)

focal length of the lens = 35mm

calculated Length of the Distance Washer = $35 \cdot (10,1 : 15) = 24\text{mm}$

CR600x2

Full Sensor Resolution

The required focal length of the lens at full sensor resolution (1280 x 1024 Pixel) is calculated as follows:

$$\text{Focal Length [mm]} = \frac{A}{1 + \frac{B}{23}}$$

A: Distance from lens to object in mm

B: Size of the object in mm

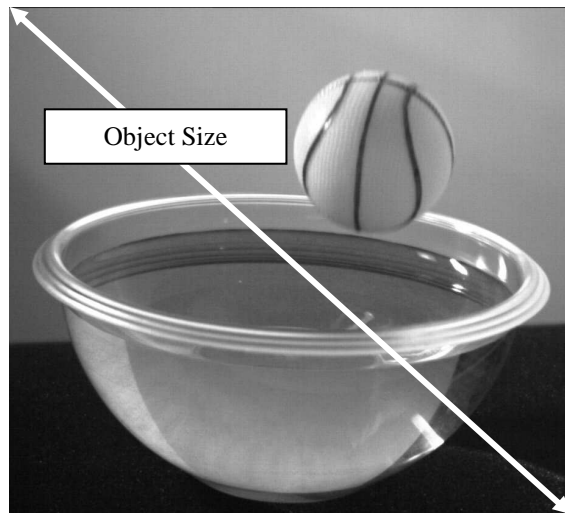

Example:

A: Distance from lens to object = 300 mm

B: Object Size = 100 mm

calculated focal length = $(300 : (1 + (100 : 23))) = 56$ mm

selected focal length = 50 mm

Reduced Sensor Resolution

At reduced sensor resolutions (e.g. 800 horizontal x 600 vertical pixels) the focal length is calculated as follows:

$$\text{Sensor Size [mm]} = 0,014 \cdot \sqrt{C^2 + D^2}$$

$$Focal\ Length\ [mm] = \frac{A}{1 + \frac{B}{Sensor\ Size\ [mm]}}$$

A: Distance from lens to object in mm

B: Object size in mm

C: Number of horizontal pixels

D: Number of vertical pixels

$$Sensor\ Size\ [mm] = 0,014 \cdot \sqrt{800^2 + 600^2} = 14$$

Example:

C: Number of horizontal pixels = 800

D: Number of vertical pixels = 600

A: Distance from lens to object = 300 mm

B: Object size = 100 mm

calculated focal length = $(300 : (1 + (100 : 14))) = 36,8$ mm

when a lens with focal length of 35 mm has to be used, and the object size has to be kept at 100 mm, the distance from lens to object has to be changed as follows:

$$Distance\ to\ Object\ [mm] = Focal\ Length \cdot \left(1 + \frac{Object\ Size}{Sensor\ Size}\right)$$

at a focal length of 35mm, an object size of 100mm and a sensor size of 14mm the new distance from lens to object is calculated as:

$$35 \cdot (1 + (100 : 14)) = 285\ mm$$

The distance from lens to object has to be reduced from 300mm to 285mm

Vice versa, when the distance from lens to object has to be reduced, the focus of the lens will come to its limit. and the required magnification factor

can no more performed by the lens itself. In this case, a distance washer has to be placed between the lens interface of the camera and the lens.

Distance Washer

The length of the distance washer can be calculated as follows:

$$\text{Length of the Distance Washer [mm]} = \text{Focal Length} \cdot \frac{\text{Sensor Size}}{\text{Object Size}}$$

Example:

Sensor Size as calculated above = 14mm

required Object Size=14mm

(The required magnification factor is = 1 : 1)

focal length of the lens = 35mm

calculated Length of the Distance Washer = 35 · (14 : 14) = 35mm

CR1000x2

Full Sensor Resolution

The required focal length of the lens at full sensor resolution (1280 x 1024 Pixel) is calculated as follows:

$$Focal\ Length\ [mm] = \frac{A}{1 + \frac{B}{19,67}}$$

A: Distance from lens to object in mm

B: Size of the object in mm

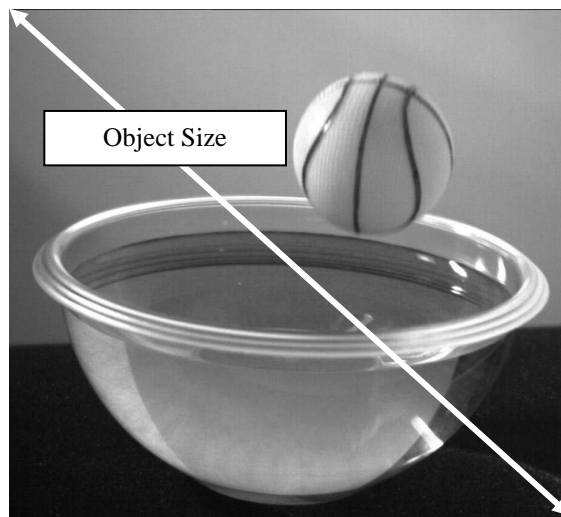

Example:

A: Distance from lens to object = 300 mm

B: Object Size = 100 mm

calculated focal length = $(300 : (1 + (100 : 19,67))) = 49\ mm$

selected focal length = 50 mm

Reduced Sensor Resolution

At reduced sensor resolutions (e.g. 800 horizontal x 600 vertical pixels) the focal length is calculated as follows:

$$Sensor\ Size\ [mm] = 0,012 \cdot \sqrt{C^2 + D^2}$$

$$Focal\ Length\ [mm] = \frac{A}{1 + \frac{B}{Sensor\ Size\ [mm]}}$$

A: Distance from lens to object in mm

B: Object size in mm

C: Number of horizontal pixels

D: Number of vertical pixels

Example:

C: Number of horizontal pixels = 800

D: Number of vertical pixels = 600

$$Sensor\ Size\ [mm] = 0,012 \cdot \sqrt{800^2 + 600^2} = 12$$

A: Distance from lens to object = 300 mm

B: Object size = 100 mm

calculated focal length = (300 : (1 + (100 : 12))) = 32,14 mm

when a lens with focal length of 35 mm has to be used, and the object size has to be kept at 100 mm, the distance from lens to object has to be changed as follows:

$$Distance\ to\ Object\ [mm] = Focal\ Length \cdot \left(1 + \frac{Object\ Size}{Sensor\ Size} \right)$$

at a focal length of 35mm, an object size of 100mm and a sensor size of 12mm the new distance from lens to object is calculated as:

$$35 \cdot (1 + (100 : 12)) = 327\ mm$$

The distance from lens to object has to be increased from 300mm to 327mm.

Vice versa, when the distance from lens to object has to be reduced, the focus of the lens will come to its limit. and the required magnification factor

can no more performed by the lens itself. In this case, a distance washer has to be placed between the lens interface of the camera and the lens.

Distance Washer

The length of the distance washer can be calculated as follows:

$$\text{Length of the Distance Washer [mm]} = \text{Focal Length} \cdot \frac{\text{Sensor Size}}{\text{Object Size}}$$

Example:

Sensor Size as calculated above = 12mm

required Object Size=12mm

(The required magnification factor is = 1 : 1)

focal length of the lens = 35mm

calculated Length of the Distance Washer = $35 \cdot (12 : 12) = 35\text{mm}$

CR3000x2

Full Sensor Resolution

The required focal length of the lens at full sensor resolution (1696 x 1710 Pixel) is calculated as follows:

$$Focal\ Length\ [mm] = \frac{A}{1 + \frac{B}{19,27}}$$

A: Distance from lens to object in mm

B: Size of the object in mm

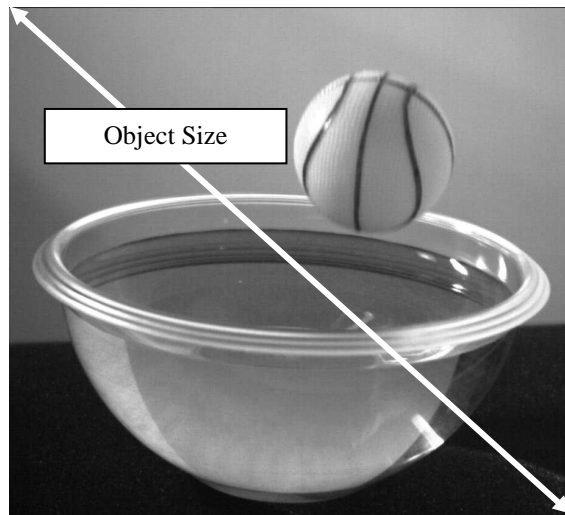

Example:

A: Distance from lens to object = 300 mm

B: Object Size = 100 mm

calculated focal length = $(300 : (1 + (100 : 19,27))) = 48\ mm$

selected focal length = 50 mm

Reduced Sensor Resolution

At reduced sensor resolutions (e.g. 1200 horizontal x 1200 vertical pixels) the focal length is calculated as follows:

$$Sensor\ Size\ [mm] = 0,008 \cdot \sqrt{C^2 + D^2}$$

$$Focal\ Length\ [mm] = \frac{A}{1 + \frac{B}{Sensor\ Size\ [mm]}}$$

A: Distance from lens to object in mm

B: Object size in mm

C: Number of horizontal pixels

D: Number of vertical pixels

Example:

C: Number of horizontal pixels = 1200

D: Number of vertical pixels = 1200

$$Sensor\ Size\ [mm] = 0,008 \cdot \sqrt{1200^2 + 1200^2} = 13,6$$

A: Distance from lens to object = 300 mm

B: Object size = 100 mm

calculated focal length = (300 : (1 + (100 : 13,6))) = 36 mm

when a lens with focal length of 35 mm has to be used, and the object size has to be kept at 100 mm, the distance from lens to object has to be changed as follows:

$$Distance\ to\ Object\ [mm] = Focal\ Length \cdot \left(1 + \frac{Object\ Size}{Sensor\ Size} \right)$$

at a focal length of 35mm, an object size of 100mm and a sensor size of 15,4mm the new distance from lens to object is calculated as:

$$35 \cdot (1 + (100 : 13,6)) = 292\ mm$$

The distance from lens to object has to be reduced from 300mm to 292mm.

Vice versa, when the distance from lens to object has to be reduced, the focus of the lens will come to its limit. and the required magnification factor

can no more performed by the lens itself. In this case, a distance washer has to be placed between the lens interface of the camera and the lens.

Distance Washer

The length of the distance washer can be calculated as follows:

$$\text{Length of the Distance Washer [mm]} = \text{Focal Length} \cdot \frac{\text{Sensor Size}}{\text{Object Size}}$$

Example:

Sensor Size as calculated above = 13,6mm

required Object Size=13,6mm

(The required magnification factor is = 1 : 1)

focal length of the lens = 35mm

calculated Length of the Distance Washer = $35 \cdot (13,6 : 13,6) = 35\text{mm}$

CR4000x2

Full Sensor Resolution

The required focal length of the lens at full sensor resolution (2304 x 1720 Pixel) is calculated as follows:

$$Focal\ Length\ [mm] = \frac{A}{1 + \frac{B}{20,126}}$$

A: Distance from lens to object in mm

B: Size of the object in mm

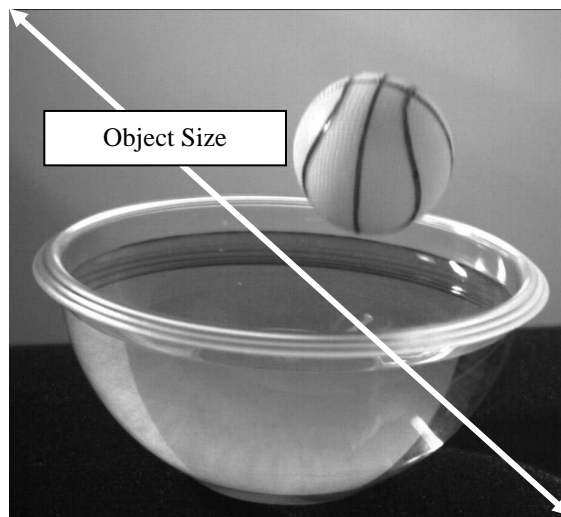

Example:

A: Distance from lens to object = 300 mm

B: Object Size = 100 mm

calculated focal length = $(300 : (1 + (100 : 20,126))) = 50\ mm$

selected focal length = 50 mm

Reduced Sensor Resolution

At reduced sensor resolutions (e.g. 1920 horizontal x 1080 vertical pixels) the focal length is calculated as follows:

$$Sensor\ Size\ [mm] = 0,007 \cdot \sqrt{C^2 + D^2}$$

$$Focal\ Length\ [mm] = \frac{A}{1 + \frac{B}{Sensor\ Size\ [mm]}}$$

A: Distance from lens to object in mm

B: Object size in mm

C: Number of horizontal pixels

D: Number of vertical pixels

Example:

C: Number of horizontal pixels = 1920

D: Number of vertical pixels = 1080

$$Sensor\ Size\ [mm] = 0,007 \cdot \sqrt{1920^2 + 1080^2} = 15,4$$

A: Distance from lens to object = 300 mm

B: Object size = 100 mm

calculated focal length = (300 : (1 + (100 : 15,4))) = 40 mm

when a lens with focal length of 35 mm has to be used, and the object size has to be kept at 100 mm, the distance from lens to object has to be changed as follows:

$$Distance\ to\ Object\ [mm] = Focal\ Length \cdot \left(1 + \frac{Object\ Size}{Sensor\ Size}\right)$$

at a focal length of 35mm, an object size of 100mm and a sensor size of 15,4mm the new distance from lens to object is calculated as:

$$35 \cdot (1 + (100 : 15,4)) = 262\ mm$$

The distance from lens to object has to be reduced from 300mm to 262mm.

Vice versa, when the distance from lens to object has to be reduced, the focus of the lens will come to its limit. and the required magnification factor

can no more performed by the lens itself. In this case, a distance washer has to be placed between the lens interface of the camera and the lens.

Distance Washer

The length of the distance washer can be calculated as follows:

$$\text{Length of the Distance Washer [mm]} = \text{Focal Length} \cdot \frac{\text{Sensor Size}}{\text{Object Size}}$$

Example:

Sensor Size as calculated above = 15,4mm

required Object Size=15,4mm

(The required magnification factor is = 1 : 1)

focal length of the lens = 35mm

calculated Length of the Distance Washer = $35 \cdot (15,4 : 15,4) = 35\text{mm}$

CR5000x2

Full Sensor Resolution

The required focal length of the lens at full sensor resolution (512 x 512 Pixel) is calculated as follows:

$$\text{Focal Length [mm]} = \frac{A}{1 + \frac{B}{11,58}}$$

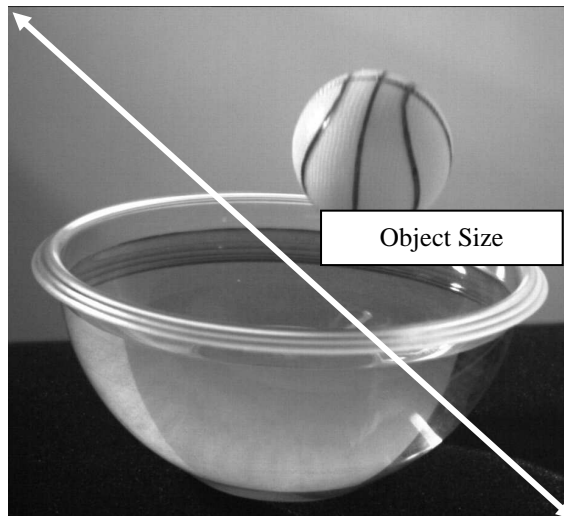

A: Distance from lens to object in mm

B: Size of the object in mm

Example:

A: Distance from lens to object = 300 mm

B: Object Size = 100 mm

calculated focal length = $(300 : (1 + (100 : 11,58))) = 31$ mm

selected focal length = 35 mm

Reduced Sensor Resolution

At reduced sensor resolutions (e.g. 256 horizontal x 256 vertical pixels) the focal length is calculated as follows:

$$\text{Sensor Size [mm]} = 0,016 \cdot \sqrt{C^2 + D^2}$$

$$\text{Focal Length [mm]} = \frac{A}{1 + \frac{B}{\text{Sensor Size [mm]}}}$$

A: Distance from lens to object in mm

B: Object size in mm

C: Number of horizontal pixels

D: Number of vertical pixels

Example:

C: Number of horizontal pixels = 256

D: Number of vertical pixels = 256

$$\text{Sensor Size [mm]} = 0,016 \cdot \sqrt{256^2 + 256^2} = 5.6$$

A: Distance from lens to object = 300 mm

B: Object size = 100 mm

calculated focal length = $(300 : (1 + (100 : 5.6))) = 16 \text{ mm}$

when a lens with focal length of 15 mm has to be used, and the object size has to be kept at 100 mm, the distance from lens to object has to be changed as follows:

$$\text{Distance to Object [mm]} = \text{Focal Length} \cdot \left(1 + \frac{\text{Object Size}}{\text{Sensor Size}} \right)$$

at a focal length of 15mm, an object size of 100mm and a sensor size of 5.6mm the new distance from lens to object is calculated as:

$$15 \cdot (1 + (100 : 5.6)) = 282 \text{ mm}$$

The distance from lens to object has to be increased from 300mm to 282mm.

Vice versa, when the distance from lens to object has to be reduced, the focus of the lens will come to its limit. and the required magnification factor can no more performed by the lens itself. In this case, a distance washer has to be placed between the lens interface of the camera and the lens.

Distance Washer

The length of the distance washer can be calculated as follows:

$$\text{Length of the Distance Washer [mm]} = \text{Focal Length} \cdot \frac{\text{Sensor Size}}{\text{Object Size}}$$

Example:

Sensor Size as calculated above = 5.6mm

required Object Size=5.6mm

(The required magnification factor is = 1 : 1)

focal length of the lens = 15mm

calculated Length of the Distance Washer = $15 \cdot (5.6 : 5.6) = 15\text{mm}$

Illumination

For questions concerning the illumination for the high-speed application please do not hesitate to contact Optronis GmbH.